

This document reproduces the complete and unabridged text of a United States Army Field Manual first published by the Department of the Army, Washington DC.

All source material contained in the reproduced document has been approved for public release and unlimited distribution by an agency of the US Government. Any US Government markings in this reproduction that indicate limited distribution or classified material have been superseded by downgrading instructions that were promulgated by an agency of the US government after the original publication of the document.

No US government agency is associated with the publishing of this reproduction.

Digital viewer interface reformatting, viewer interface bookmarks and viewer interface links were revised, edited, ammended, and or provided for this edition by I.L. Holdridge.

This page and the viewer interface reformatting
© I.L. Holdridge 1999.
All rights reserved.

Field Manual
No. 23-14

HEADQUARTERS
DEPARTMENT OF THE ARMY
Washington, DC, 26 January 1994

M249 LIGHT MACHINE GUN IN THE AUTOMATIC RIFLE ROLE

CONTENTS

	Page
PREFACE	v
CHAPTER 1. DESCRIPTION AND COMPONENTS	
1-1. Description	1-1
1-2. Components	1-1
1-3. Ammunition	1-6
1-4. Blank Firing Attachment	1-9
CHAPTER 2. MAINTENANCE	
2-1. Clearing Procedures	2-1
2-2. General Disassembly	2-4
2-3. Inspection	2-11
2-4. Cleaning, Lubrication, and Preventive Maintenance	2-12
2-5. General Assembly	2-17
2-6. Function Check	2-21
2-7. Maintenance Procedures	2-21
2-8. Maintenance During NBC Conditions	2-22
CHAPTER 3. OPERATION AND FUNCTION	
3-1. Operation	3-1
3-2. Loading	3-1
3-3. Unloading	3-3
3-4. Cycle of Functioning	3-3
3-5. Sight Settings and Corrections	3-5
3-6. Bipod Positioning	3-7

DISTRIBUTION RESTRICTION: Approved for public release; distribution is unlimited.

*This publication supersedes FM 23-14, 10 December 1985; and rescinds

DA Form 5503-R, December 1985.

	Page
CHAPTER 4. PERFORMANCE PROBLEMS AND DESTRUCTION	
4-1. Malfunctions	4-1
4-2. Stoppages	4-2
4-3. Immediate Action	4-3
4-4. Remedial Action	4-4
4-5. Destruction Procedures	4-4
CHAPTER 5. MARKSMANSHIP TRAINING	
Section 1. Introduction to Marksmanship	5-1
5-1. Objectives	5-1
5-2. Training Phases	5-1
5-3. Training Strategy	5-2
5-4. Training for Combat Conditions	5-5
Section II. Preliminary Marksmanship Training	5-5
5-5. Fundamentals, Marksmanship	5-5
5-6. Fundamentals, Firing Positions	5-7
5-7. Fundamentals, Night Firing	5-9
5-8. Fundamentals: Nuclear, Biological, and Chemical	5-10
5-9. Fundamentals, Moving Targets	5-11
5-10. Fundamentals, Traverse and Search	5-14
5-11. Direct Lay	5-14
5-12. Application of Fire	5-14
5-13. Adjustment of Fire	5-14
5-14. Effects of Wind	5-16
5-15. Fire Commands	5-18
5-16. Dry-Fire Exercises	5-19
5-17. Multipurpose Machine Gun Range Layout	5-21
5-18. Basic Machine Gun Target	5-23
5-19. Target Analysis	5-26
5-20. 10-Meter Scoring Procedures	5-26
Section III. Basic Marksmanship, Live-Fire Exercises	5-27
5-21. Zeroing	5-27
5-22. Field Zeroing	5-29
5-23. 10-Meter Firing	5-30
5-24. 10-Meter Conduct of Fire	5-31
5-25. 10-Meter Firing, Qualification	5-36
5-26. Transition Firing	5-37
5-27. Transition Conduct of Fire	5-38

	Page
5-28. Transition Firing, Limited Visibility	5-42
5-29. Zeroing the AN/PVS-4	5-43
5-30. Qualification Standards	5-50
CHAPTER 6. COMBAT TECHNIQUES OF FIRE	
Section I. Introduction6-1
6-1. Characteristics of Fire6-1
6-2. Classes of Fire6-2
Section II. Application of Fire6-5
6-3. Types of Targets6-6
6-4. Distribution, Concentration, and Rate of Fire6-7
6-5. Target Engagement6-8
6-6. Target Engagement During Limited Visibility	6-14
Section III. Predetermined Fires	6-14
6-7. Terminology	6-14
6-8. Range Card	6-16
Section IV. Fire Control	6-22
6-9. Methods of Fire Control	6-22
6-10. Fire Commands	6-24
Section V. Range Determination	6-30
6-11. Range Estimation	6-30
6-12. Lateral Distance Measurement	6-34
Section VI. Advanced Automatic Rifle Marksmanship	6-34
6-13. Field Firing Exercise	6-34
6-14. Alternate Firing Positions	6-36
6-15. Movement, Speed, and Alignment	6-39
6-16. Reloading	6-39
6-17. Alternate Firing Position Exercises	6-40
CHAPTER 7. TRAIN-THE-TRAINER PROGRAM	
Section I. Organization7-1
7-1. Objectives7-1
7-2. Mission-Essential Task List7-1
7-3. Trainer Assessment7-1
7-4. Cadre Coaches7-2
7-5. Command Benefits7-3
7-6. Program Phases7-4

	Page
Section II. Training Tasks	7-4
7-7. Phase I, Preliminary Marksmanship Training	7-5
7-8. Phase II, Basic Marksmanship Training	7-7
7-9. Phase III, Advanced Marksmanship Training	7-9
Section III. Trainer Certification Program	7-10
7-10. Training Base	7-10
7-11. Certification Program Outline	7-11
APPENDIX A. UNIT TRAINING PROGRAM	A-1
APPENDIX B. PROFICIENCY (PERFORMANCE) EXAMINATION	B-1
APPENDIX C. M249 AUTOMATIC RIFLE IN AIR DEFENSE	C-1
APPENDIX D. RANGE SAFETY	D-1
APPENDIX E. EMPLOYMENT	E-1
GLOSSARYGlossary-1
REFERENCES	References-1
INDEXIndex-1

PREFACE

This manual provides technical information, training techniques, and guidance on the M249 light machine gun in the automatic rifle role, which was formerly known as the squad automatic weapon (SAW). Since this manual addresses the M249's use in the automatic rifle role as opposed to the light machine gun role, it is referred to in this manual as the M249 AR. Unit leaders and the designated automatic riflemen will find this information invaluable in their efforts to successfully integrate this automatic weapon into their combat operations.

The tactical positions shown in this manual may not be tactically correct, but they were drawn to enhance the reader's understanding of related subject material.

Unless this publication states otherwise, masculine nouns and pronouns do not refer exclusively to men.

The proponent of this publication is the United States Army Infantry School. Send comments and recommendations on DA Form 2028 directly to Commandant, US Army Infantry School, ATTN: ATSH-IN-S3, Fort Benning, GA 31905-5596.

CHAPTER 1

DESCRIPTION AND COMPONENTS

This chapter describes the weapon and the types of ammunition in detail and provides a table of general data.

1-1. DESCRIPTION

The M249 AR is a gas-operated, air-cooled, belt-and magazine-fed, automatic weapon that fires from the open-bolt position (Figure 1-1). It has a maximum rate of fire of 850 rounds per minute. Primarily, ammunition is fed into the weapon from a 200-round ammunition box containing a disintegrating metallic split-link belt. As an emergency means of feeding, the M249 AR can use a 20- or 30-round M16 rifle magazine, but this will increase the chance of stoppages. Although the M249 AR is primarily used as an automatic rifle, it is also used as a light machine gun. It can be fired from the shoulder, hip, or underarm position; or from the biped-steadied position. When employed as a machine gun, it has a tripod with a T&E mechanism and a spare barrel; however, barrels must not be interchanged with those from other M249s unless the headspace has been set for that weapon by direct support personnel.

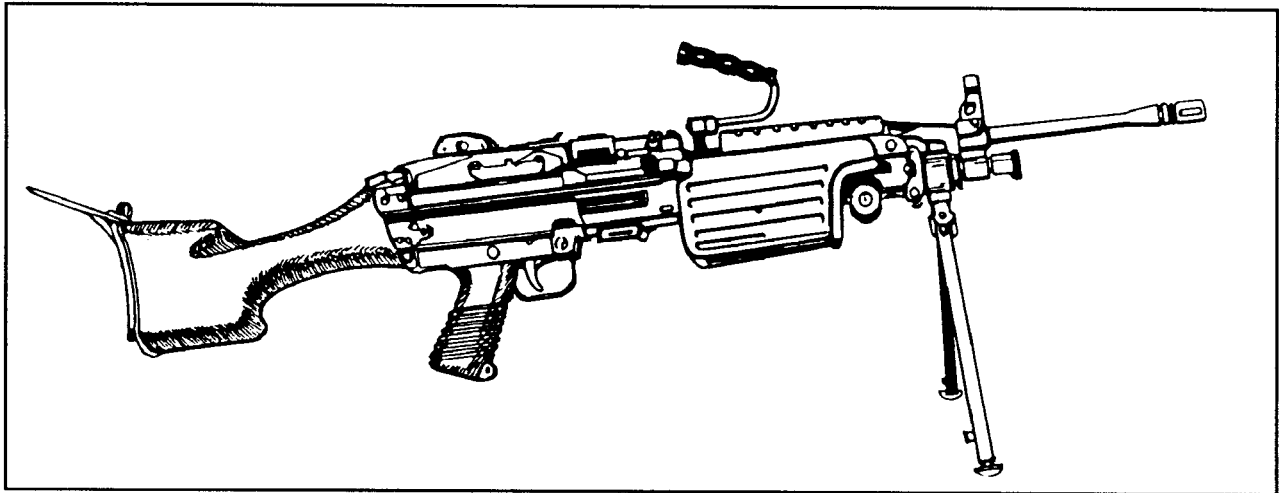

Figure 1-1. M249 automatic rifle.

1-2. COMPONENTS

The major components of the M249 AR and their purposes are shown in Table 1-1, page 1-2; and Figure 1-2, page 1-3. The sights and safety button are discussed in paragraphs a and b and shown in Figures 1-3 and 1-4, pages 1-5 and 1-6, respectively. See Table 1-2, page 1-4, for general data.

COMPONENTS	PURPOSES
Barrel assembly (1)	Houses cartridges for firing, directs projectile, and supports the gas regulator.
Heat shield assembly (2)	Provides protection for the automatic rifleman's hand from a hot barrel.
Rear sight assembly (3)	Adjusts for both windage and elevation.
Cover and feed mechanism assembly (4)	Feeds linked belt ammunition, and positions and holds cartridges in position for stripping, feeding, and chambering.
Feed tray assembly (5)	Positions belted ammunition for firing.
Cocking handle assembly (6)	Pulls the moving parts rearward. Moves in a guide rail fixed to the right side of the receiver.
Buttstock and buffer assembly (7)	Contains a folding buttplate. Serves as a shoulder support for aiming and firing M249. Contains a buffer to absorb recoil.
Bolt assembly (8)	Provides feeding, stripping, chambering, firing, and extraction, using the projectile gases for power.
Slide assembly (9)	Houses firing pin and roller assembly.
Return rod and transfer mechanism assembly (10)	Absorbs recoil for bolt and operating rod assembly at the end of recoil movement.
Receiver assembly (11)	Serves as a support for all major components and houses action of weapon. Through a series of cam ways, controls functioning of weapon.
Trigger mechanism (12)	Controls the firing of the weapon. Provides storage area for lubricant in grip portion.
Handguard assembly (13)	Provides thermal insulation to protect the automatic rifleman's hands from heat or extreme cold and houses the cleaning equipment.
Sling and snap hook assembly (14)	Provides a means of carrying the weapon.
Bipod (15)	Supports M249 AR in prone position. The telescopic legs can be individually adjusted to three different lengths.
Gas cylinder assembly (16)	Locks bipod in place and provides passageway for operating gases.
Piston assembly (17)	Holds the bolt and slide assemblies and houses the return spring.
Return spring (18)	Returns bolt, slide, and piston assemblies to locked position during counter-recoil cycle.

Table 1-1. Components and purposes.

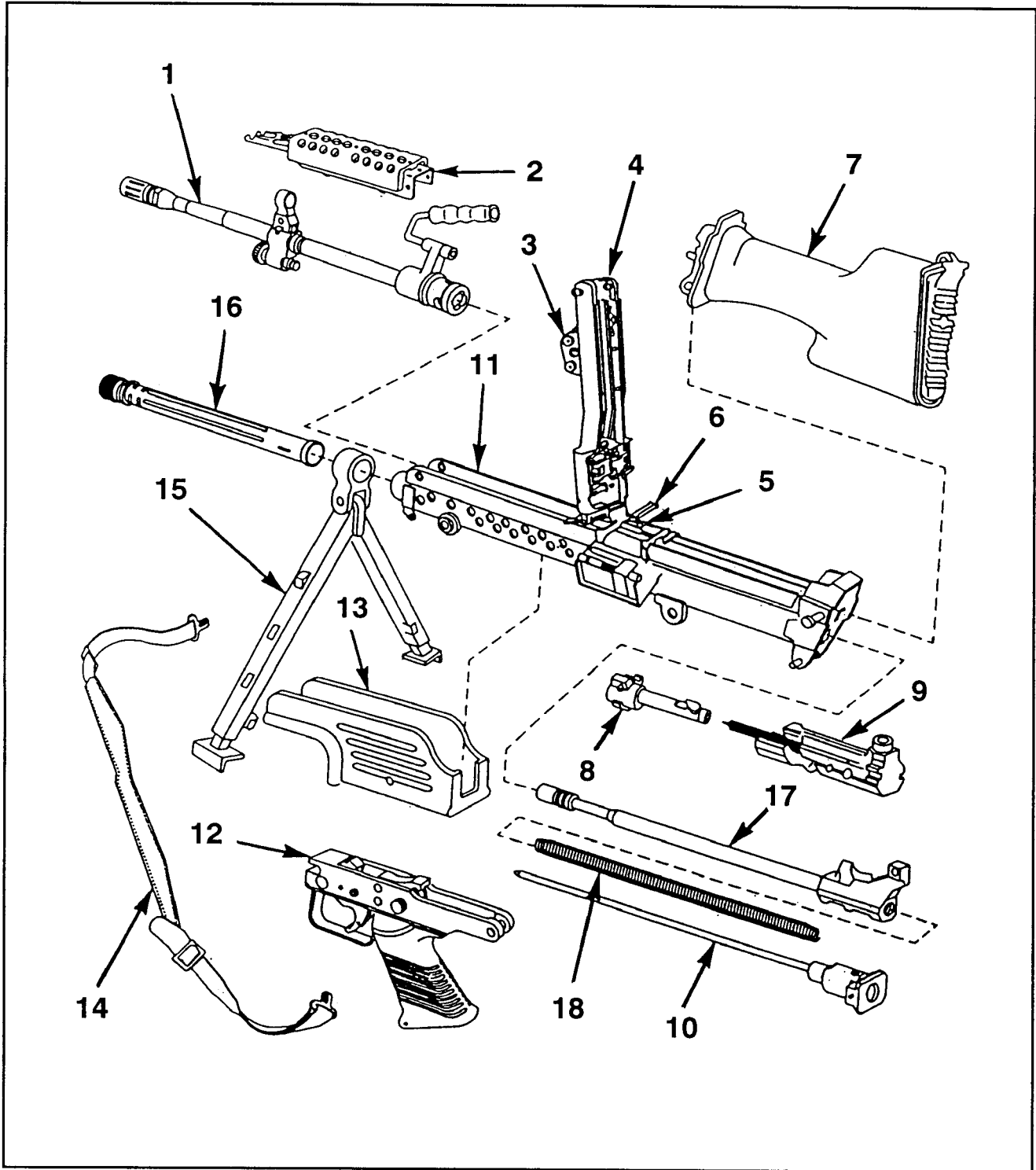

Figure 1-2. M249 AR components.

Ammunition	5.56-mm ball and tracer (mix) ammunition is packaged in 200-round boxes, each weighing 6.92 pounds; 20-round magazines, each weighing .7 pound or 30-round magazines, each weighing 1.07 pounds. Other types of ammunition available are tracer, blank, and dummy.
Tracer burnout900 meters (+)
Length of M24940.87 inches
Weight of M249	
With modification kit16.41 pounds
Without modification kit15.30 pounds
Maximum range3,600 meters
Point targets600 meters
Area targets800 meters
Suppression1,000 meters
Rates of Fire:	
Sustained85 rounds per minute (with no barrel changes)
Rapid200 rounds per minute (with barrel change after 2 minutes)
Cyclic850 rounds per minute (with barrel change after 1 minute)
Basic load, ammunition600 rounds carried by automatic rifleman in three 200-round boxes.
Maximum extent of grazing fire obtainable over uniformly sloping terrain600 meters

Table 1-2. General data.

a. **Sights.** The M249 AR has a hooded and semi-tied front sight (Figure 1-3). The rear sight assembly mounts on the top of the cover and feed mechanism assembly. The elevation knob drum has range settings from 300 meters to 1,000 meters. Range changes are made on the M249 AR sight by rotating the elevation knob to the desired range setting. Rotation of the rear sight aperture (peep sight) is used for fine changes in elevation or range adjustments, such as during zeroing. Each click of the

peep sight equals one-half-mil change in elevation, which is .5 cm at 10 meters. The sight adjusts for windage by rotating the windage knob. Each click of windage adjustment also equals a one-half-mil change, which is .5 cm at 10 meters. There is also a windage sliding scale marked with index lines for centering the rear sight aperture.

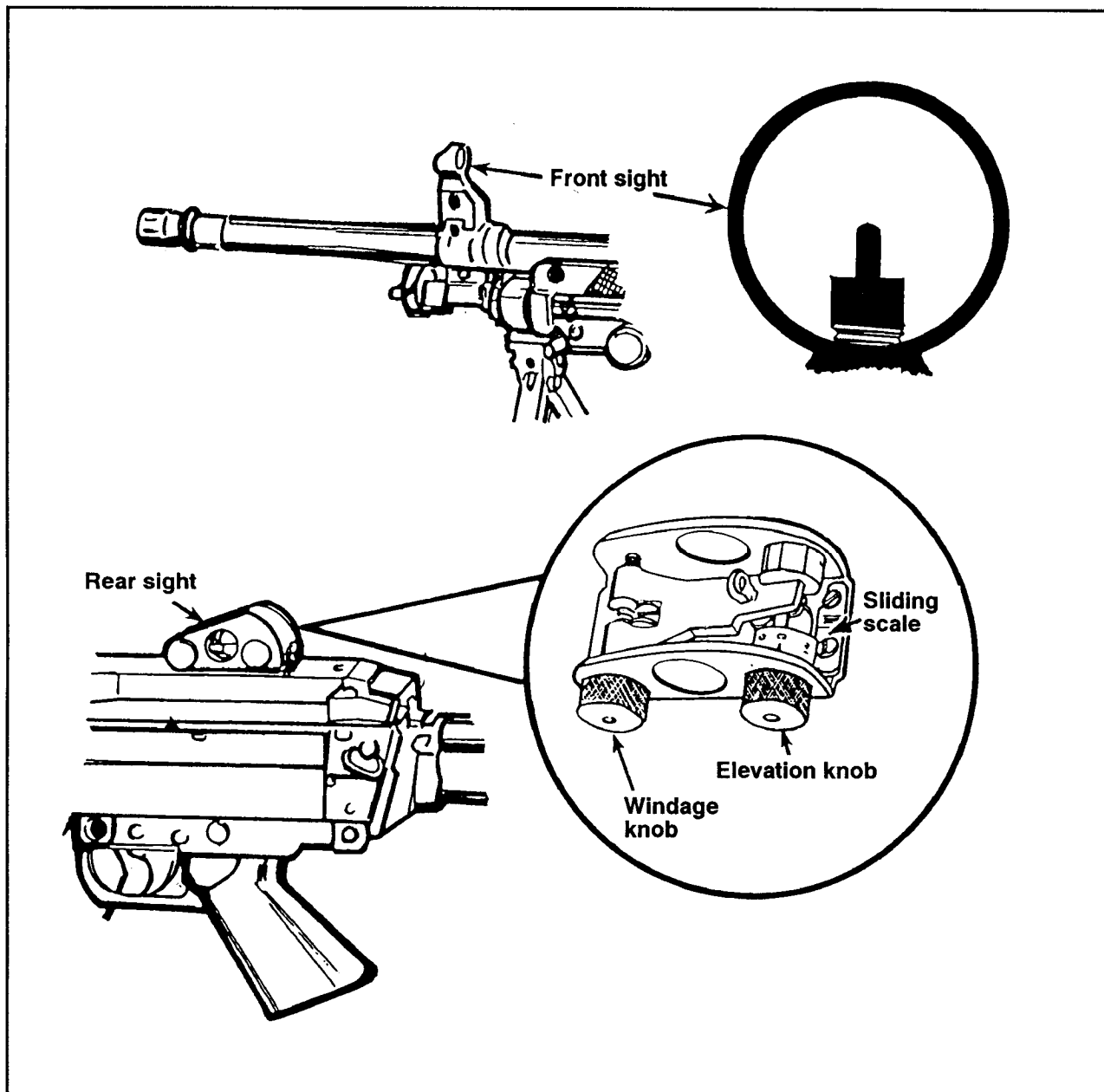

Figure 1-3. Sights.

b. **Safety.** The safety (Figure 1-4) is in the trigger housing. The safety is pushed from left to right (red ring NOT visible) to render the weapon SAFE, and the bolt cannot be released to go forward. The safety is pushed from right to left (red ring visible) to render the weapon ready to fire. The cocking handle on the right-side of the weapon is used to pull the bolt to the rear.

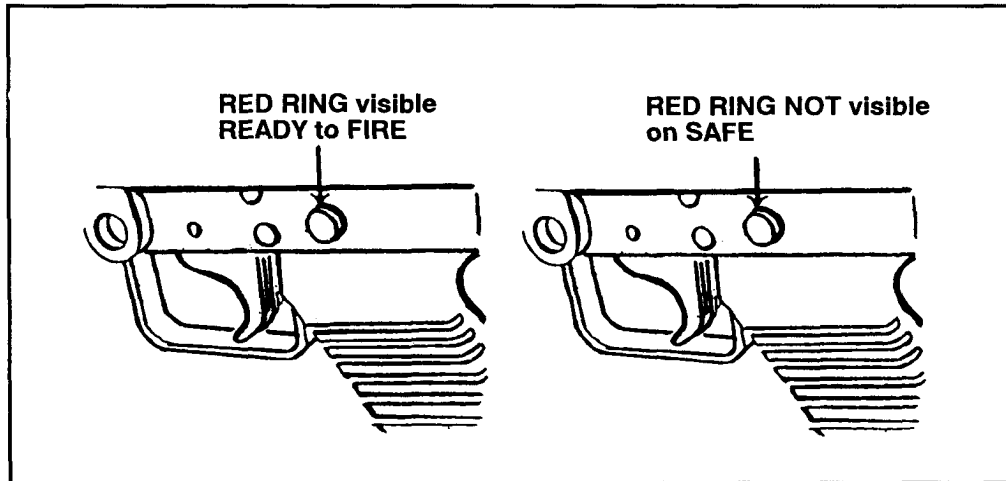

Figure 1-4. M249 AR safety.

1-3. AMMUNITION

The M249 AR uses several different types of 5.56-mm standard military ammunition. Soldiers should use only authorized ammunition that is manufactured to US and NATO specifications.

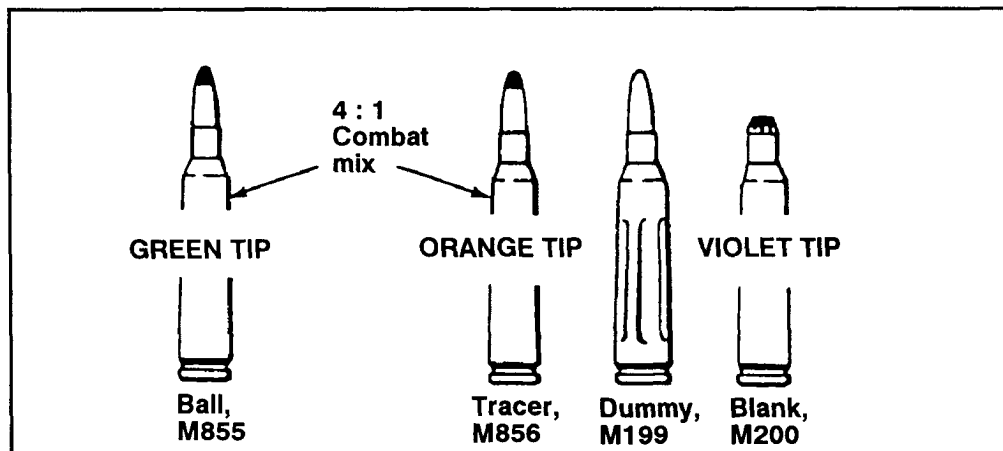

Figure 1-5. Cartridges for the M249.

a. **Type and Characteristics.** The specific type ammunition (Figure 1-5) and its characteristics are as follows.

(1) *Cartridge, 5.56-mm ball M855 (A059).* The M855 cartridge has a gilding, metal-jacketed, lead alloy core bullet with a steel penetrator. The primer and case are waterproof. The ammunition is linked by a disintegrating metallic split-linked belt for firing from the ammunition box (Figure 1-6). In an emergency, the M855 round can also be loaded and fired from the M16 20- or 30-round magazine. It is identified by a green tip, has a projectile weight of 62 grains, and is 2.3 cm long. This is the NATO standard round. It is effective against personnel and light materials, not vehicles.

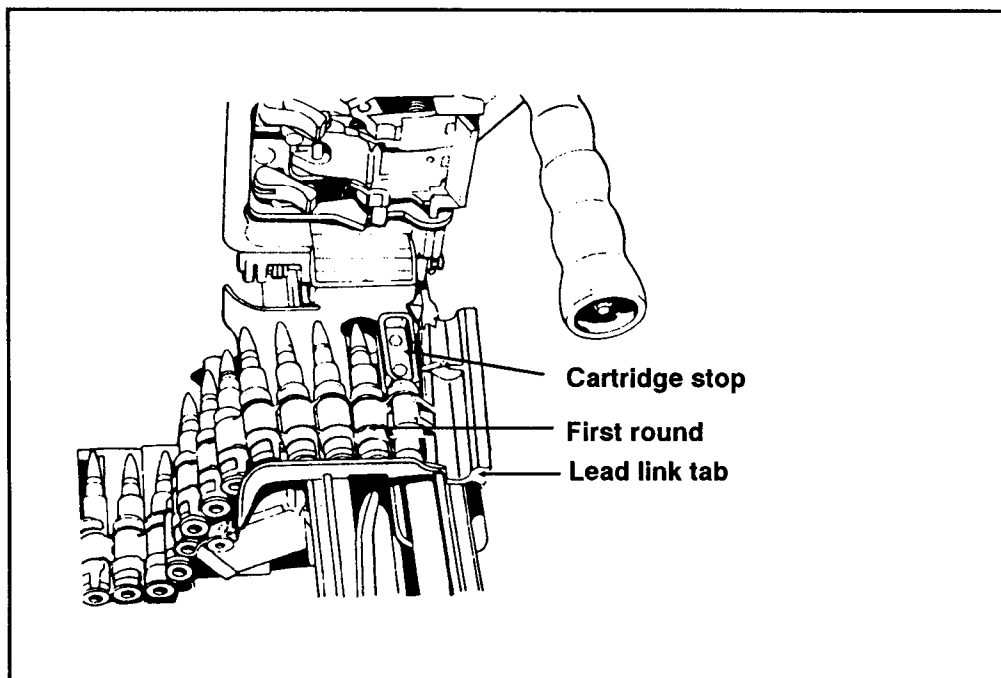

Figure 1-6. M855 cartridges in metallic belt.

(2) *Cartridge, 5.56-mm tracer, M856 (A064).* This cartridge has a 63.7 grain bullet without a steel penetrator. It is identified by an orange tip. The tracer is used for adjustments after observation, incendiary effects, and signaling. When tracer rounds are fired, they are mixed with ball ammunition in a ratio of four ball rounds to one tracer round. The DODAC for ball and tracer mix is A064.

(3) *Cartridge, 5.56-mm dummy M199 (A060).* This cartridge can be identified by the six grooves along the side of the case beginning about one-half inch from its head. It contains no propellant or primer. The primer

well is open to prevent damage to the firing pin. The dummy round is used during mechanical training, dry-fire exercises, and function checks.

NOTE: The 5.56-mm NATO cartridge may be identified by its appearance, the painting of projectile tips, the stamping of the manufacturer's initials and year of manufacture on the base of the cartridge case, and the markings on the packing containers. When removed from the original packing container, the cartridge may be identified by its physical characteristics. The M193 and M196 cartridge for the M16 can be fired with the M249, but accuracy is degraded; therefore, it should only be used in emergency situations when M855 or M856 ammunition is not available.

(4) *Cartridge, 5.56-mm blank M200 (M2 link, A075)*. The blank cartridge has no projectile. The case mouth is closed with a seven-petal rosette crimp and has a violet tip. The original M200 blank cartridge had a white tip. Field use of this cartridge resulted in residue buildup, which caused malfunctions. Only the violet-tipped M200 cartridge should be used. The blank round is used during training when simulated live fire is desired. An M15A2 blank-firing attachment must be used to fire this ammunition. (See paragraph 1-4).

DANGER

Do not fire blank ammunition at any person within 20 feet, because fragments of a closure wad or particles of unburned propellant can cause injury.

b. **Storage.** Ammunition is stored under cover. If ammunition is in the open, it must be kept at least 6 inches above the ground and covered with a double thickness of tarpaulin. The cover must be placed so that it protects the ammunition yet allows ventilation. Trenches are dug to divert water from flowing under the ammunition.

c. **Care, Handling, and Preservation.** Ammunition should not be removed from the airtight containers until ready for use. Ammunition removed from the airtight containers, particularly in damp climates, may corrode.

(1) Ammunition must be protected from mud, dirt, and moisture. If it gets wet or dirty, the ammunition must be wiped off before using. Lightly corroded cartridges are wiped off as soon as the corrosion is discovered. Heavily corroded, dented, or loose projectiles should not be fired.

(2) Ammunition must be protected from the direct rays of the sun. Excessive pressure from the heat may cause premature detonation.

(3) Oil should never be used on ammunition. Oil collects dust and other abrasives that may possibly damage the operating parts of the weapon.

d. **Packaging.** The ammunition can contains two plastic ammunition boxes. Each box contains 200 rounds and weighs 6.92 pounds. Dummy ammunition (M199) is packed in boxes of 20 rounds each.

1-4. BLANK FIRING ATTACHMENT

The M15A2 BFA is the same attachment used for the M16 rifle.

a. **Installation.** The BFA is attached to the M249 AR by using the three steps in Figure 1-7.

b. **Care of the M249 While Using the BFA.** A buildup of carbon inside the weapon causes friction between the moving parts. Carbon deposits build rapidly when blanks are fired. When these deposits become excessive, stoppages occur. Therefore, keeping the weapon clean, especially the gas system and chamber, during blank firing is very important. To get the best performance with the BFA, the automatic rifleman performs the following:

- (1) Inspects the weapon for damaged parts, excessive wear, cleanliness, and proper lubrication before firing.
- (2) When feasible, test fires the weapon using ball ammunition before attaching the BFA.
- (3) Adjusts the BFA to fit the weapon.
- (4) Applies immediate action when stoppages occur.
- (5) Cleans the gas system after firing 500 rounds.
- (6) Cleans and lubricates the entire weapon after firing 1,000 rounds.

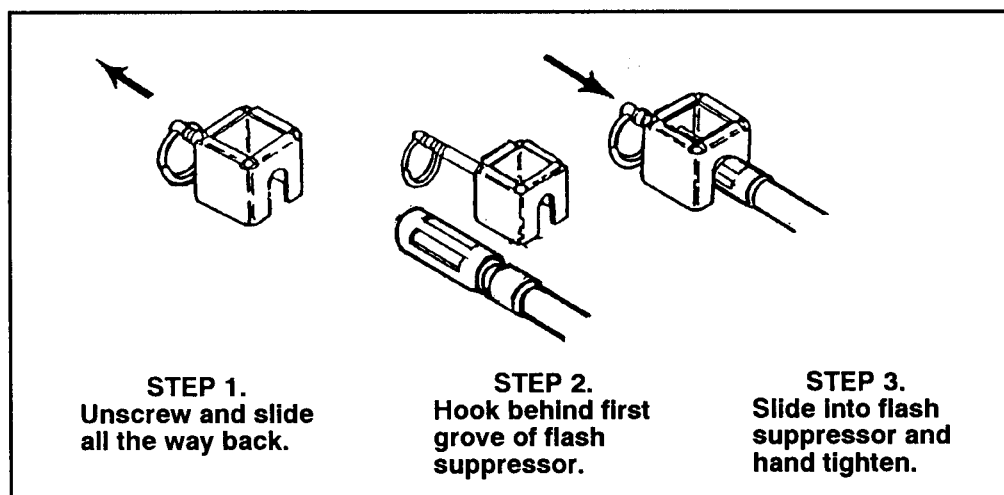

Figure 1-7. M15A2 BFA.

CHAPTER 2

MAINTENANCE

Proper maintenance contributes to weapon effectiveness as well as unit readiness. This chapter discusses the maintenance aspects of the M249 AR to include inspection; cleaning and lubrication; and maintenance before, during, and after firing and during NBC conditions. Associated tasks essential to maintenance (clearing general assembly and disassembly, and function checks) are provided in detail.

2-1. CLEARING PROCEDURES

The first step in maintenance is to clear the weapon (Figure 2-2). This applies in all situations, not just after firing. The automatic rifleman must always assume the M249 AR is loaded. To clear the M249, the automatic rifleman performs the following procedures.

- a. Moves the safety to the FIRE position by pushing it to the left until the red ring is visible.
- b. With his right hand, palm up, pulls the cocking handle to the rear, locking the bolt in place.
- c. While holding the resistance on the cocking handle, moves the safety to the SAFE position by pushing it to the right until the red ring is not visible. (The weapon cannot be placed on safe unless the bolt is locked to the rear.)
- d. Returns and locks the cocking handle in the forward position.

CAUTION

When opening the feed cover, make sure the weapon is on the ground away from your face. With the weapon on your shoulder, possible injury could occur if a round goes off when the cover is raised.

- e. Raises the cover and feed mechanism assembly, and conducts the **five-point safety check** for brass, links, or ammunition.
 1. Checks the feed pawl assembly under the feed cover.
 2. Checks the feed tray assembly.
 3. Lifts the feed tray assembly and inspects the chamber.
 4. Checks the space between the bolt assembly and the chamber.
 5. Inserts two fingers of his left hand in the magazine well to extract any ammunition or brass.
- f. Closes the cover and feed mechanism assembly and moves the safety to the FIRE position. With his right hand, palm up, returns the cocking handle to the rear position. Presses the trigger and at the same time eases the bolt forward by manually riding the cocking handle forward.

CAUTION
The cocking handle must be manually returned to the forward and locked position each time the bolt is manually pulled to the rear.

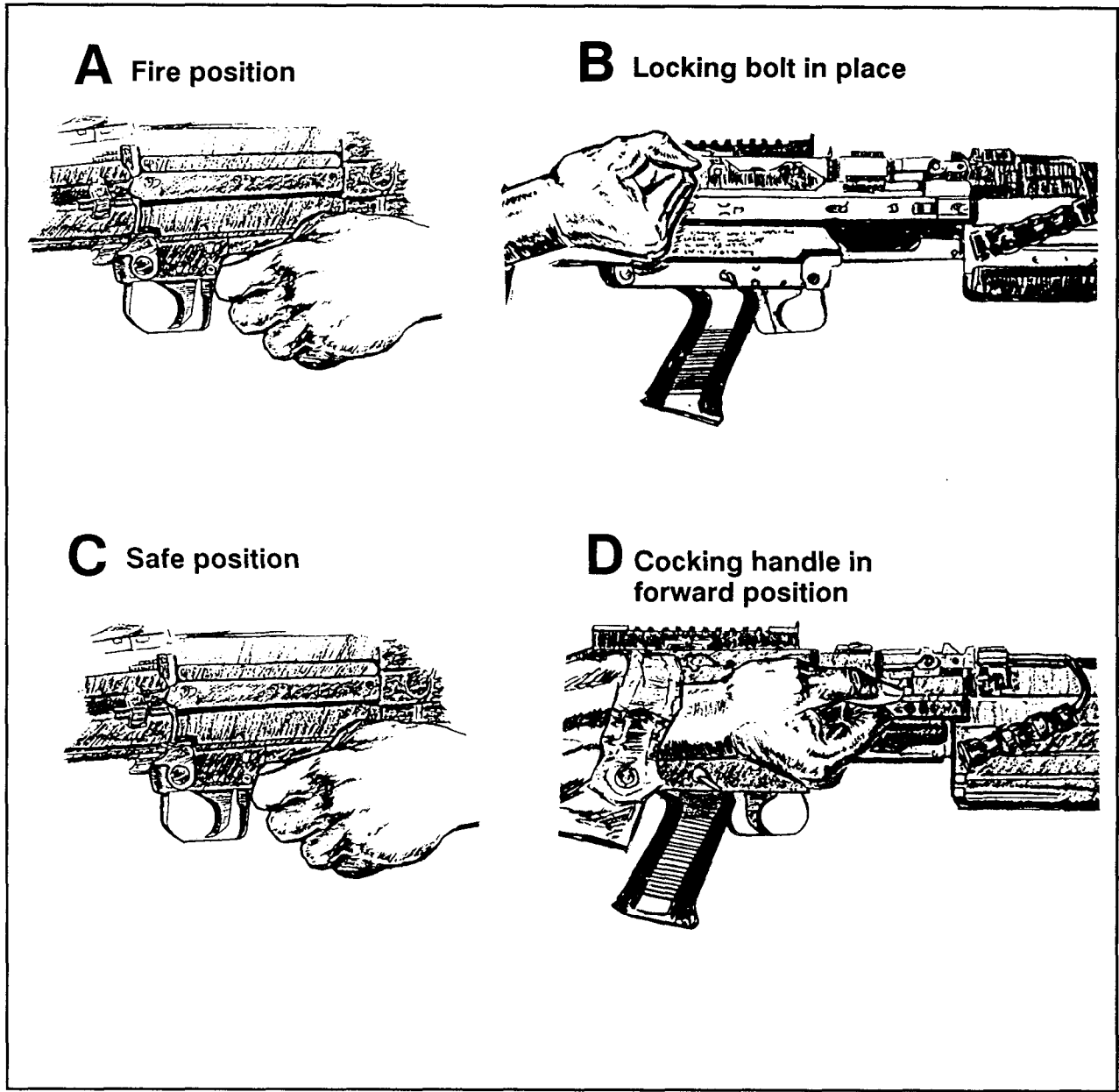

Figure 2-1. Clearing procedures.

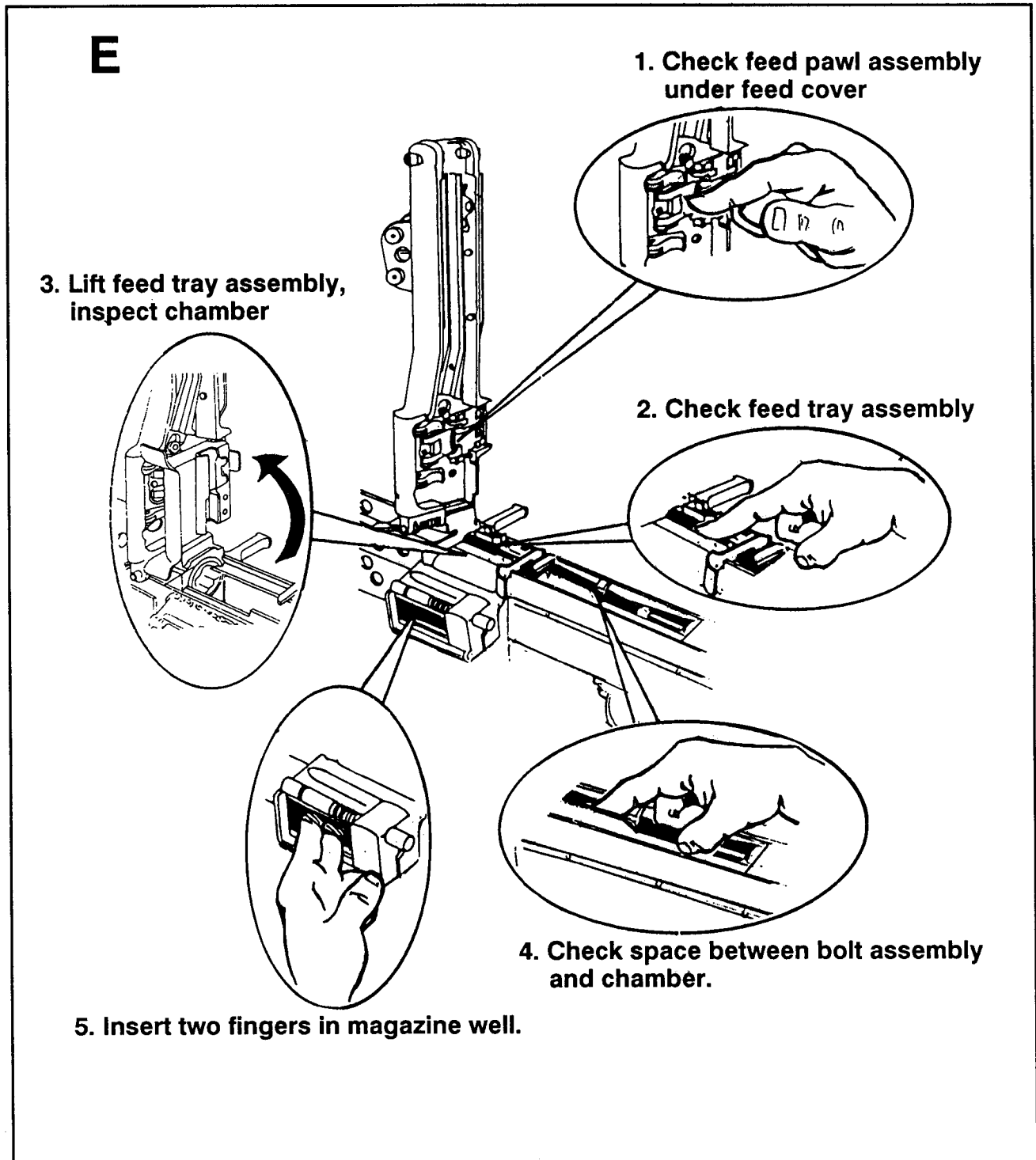

Figure 2-1. Clearing procedures (continued).

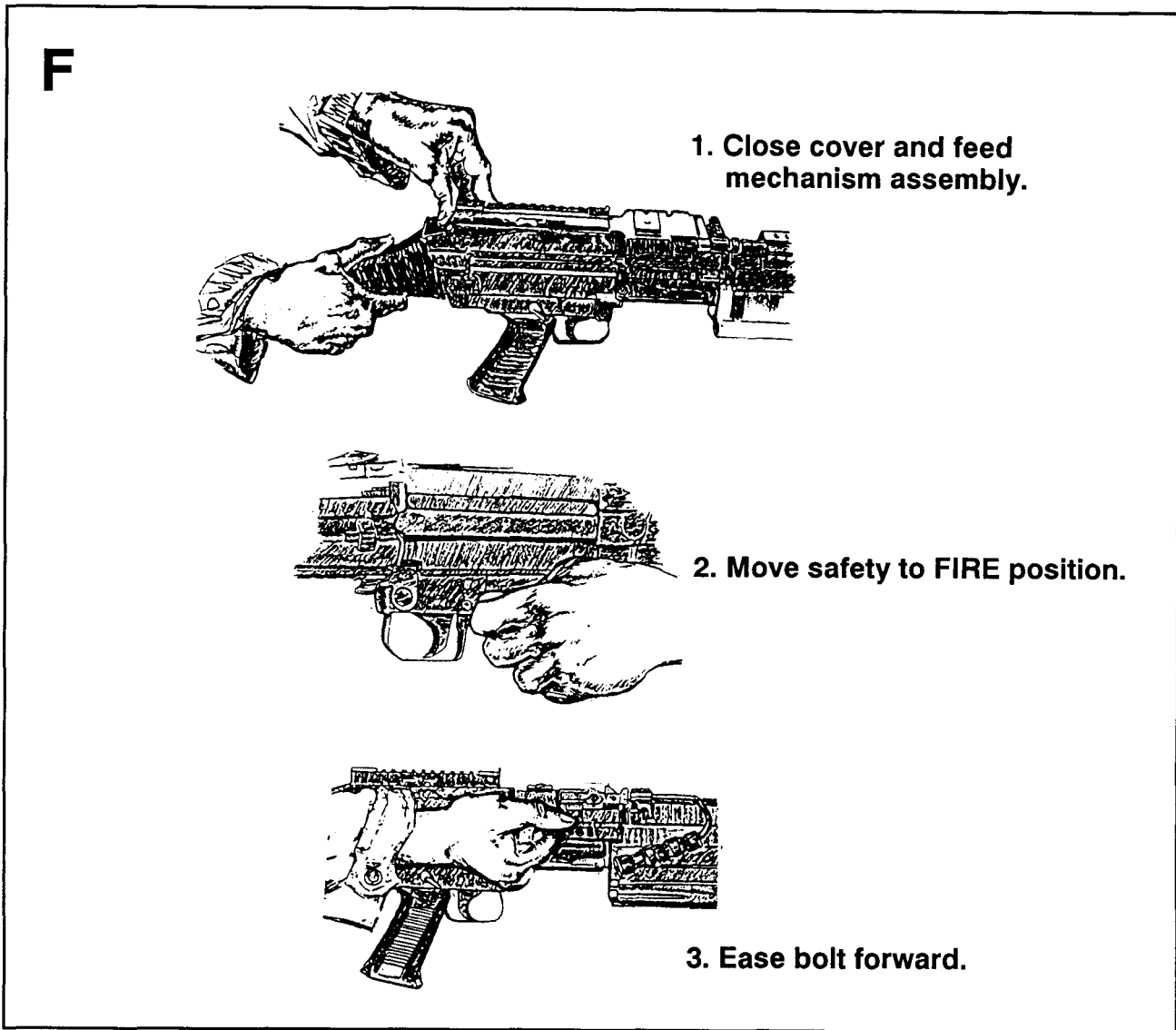

Figure 2-1. Clearing procedures (continued).

2-2. GENERAL DISASSEMBLY

General disassembly is removing and replacing the eight major groups. (Figure 2-2.) The unit armorer performs detailed disassembly. Disassembly beyond what is explained in this manual is prohibited except by ordnance personnel. During general disassembly, each part is placed on a clean flat surface such as a table or mat. This aids in assembly in reverse order and avoids the loss of parts. Before disassembling the M249, the bipod legs must be released from under the receiver and placed into the bipod mode position.

DANGER

Be sure the bolt is in the forward position before disassembly. The guide rod can cause death or injury if the guide spring is retracted with the bolt pulled to the rear.

1. Operating rod group.

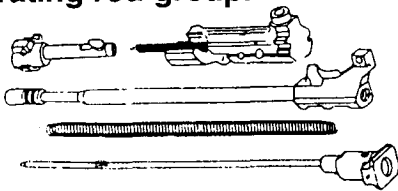

2. Barrel group.

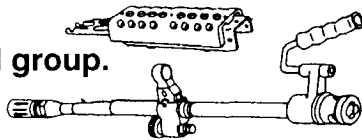

3. Handguard group.

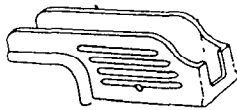

4. Buttstock and buffer assembly group.

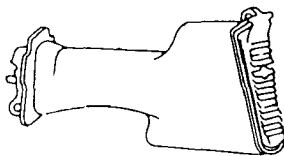

5. Trigger mechanism group.

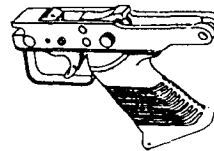

6. Gas cylinder group.

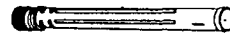

7. Bipod group.

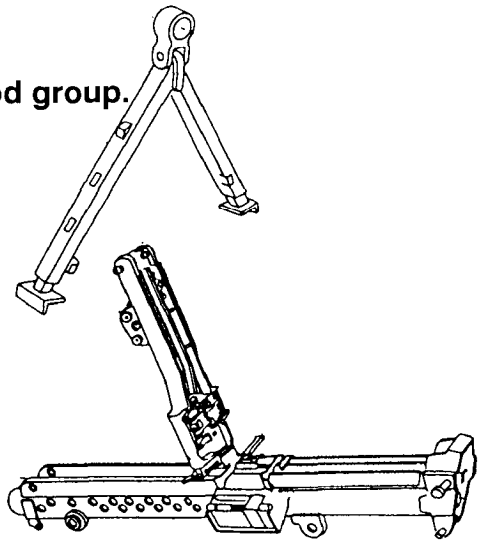

8. Receiver group.

Figure 2-2. Eight major groups.

a. **Removing the Operating Rod Group (Figure 2-3).** The operating rod group consists of the spring guide rod, operating rod spring, slide assembly, piston assembly, and bolt assembly.

(1) To remove the operating rod, pull the upper retaining pin at the rear of the receiver to the left. Allow the buttstock to pivot downward and place it on a surface to support the weapon for disassembly.

(2) To release the operating rod assembly from the positioning grooves inside the receiver, hold the weapon with one hand on the buttstock assembly and use the thumb of the other hand to push in and upward on the rear of the operating rod assembly.

(3) Pull the operating rod and spring from the receiver group and separate the parts.

(4) Hold the buttstock assembly with your left hand to stabilize the weapon. With your right hand, pull the cocking handle to the rear to lock the bolt. Return the cocking handle to the forward position. Place a finger on the face of the bolt and push until your finger makes contact with the bridge at the end of the receiver. This leaves the piston, slide, and bolt assemblies exposed.

(5) Hold the slide assembly while pulling the moving parts out the rear of the receiver.

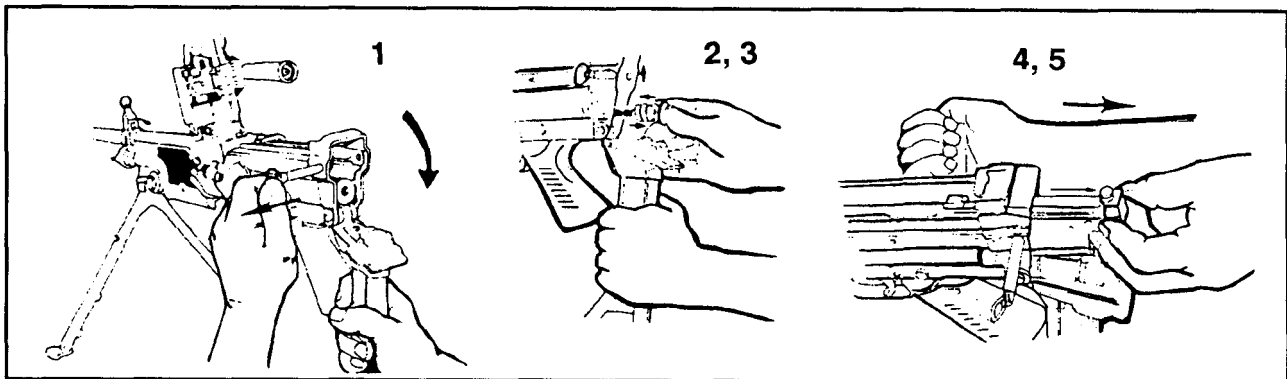

Figure 2-3. Removing the operating rod group.

(6) To separate the operating rod group (Figure 2-4), hold the piston assembly in one hand, place your other hand on the bolt assembly, and rotate the bolt to disengage the bolt from the slide assembly. Remove the firing pin spring from the firing pin, but be careful not to break the spring. If the spring sticks, rotate it clockwise to free it. The weapon will function without the spring; however, this weakens the firing pin action. To separate the slide assembly from the piston, press the retaining pin at the rear of the slide assembly to the left and lift the slide assembly.

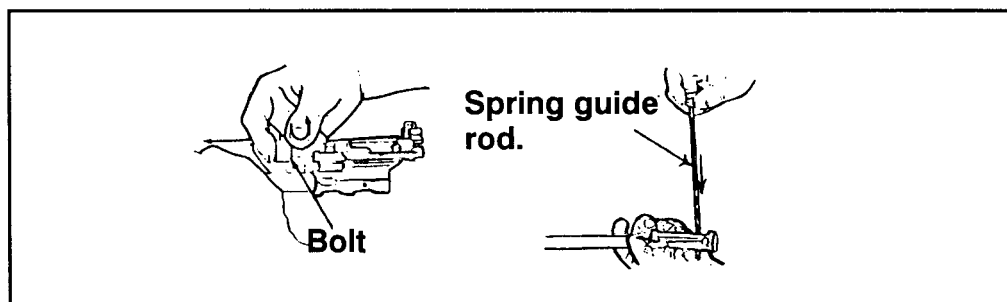

Figure 2-4. Separating the operating rod group.

b. **Removing the Barrel Group (Figure 2-5).** The barrel group consists of barrel, heat shield, flash suppressor, front sight, gas regulator, and gas regulator collar.

CAUTION

Barrels must not be interchanged with those from other M249s unless the headspace has been certified for that weapon by direct support personnel.

(1) To remove the barrel from the receiver, close the cover and feed mechanism assembly, depress the barrel locking lever with your left hand, lift the carrying handle using your right hand and push the barrel forward. To remove the heat shield, place the barrel with the muzzle end on a hard, flat surface and with the heat shield facing away from your body. Place the index fingers of each hand inside the chamber. Use your thumbs to push up on the top clip.

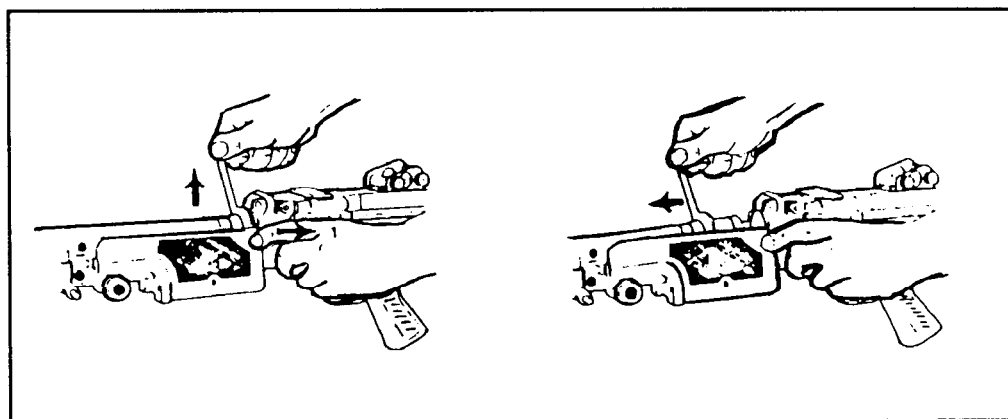

Figure 2-5. Removing the barrel.

(2) Raise the feed cover.

(3) To remove the gas regulator and collar, rotate the gas collar pin out of the notch. Place the tip of the scraper with the concave side facing the pin of the collar inside the notch. (Be careful not to use too much pressure, so as not to break the tip of the scraper.) Rotate the collar counterclockwise over the concave portion of the tip on the scraper and past the notch until the collar slides off. (Figure 2-6.)

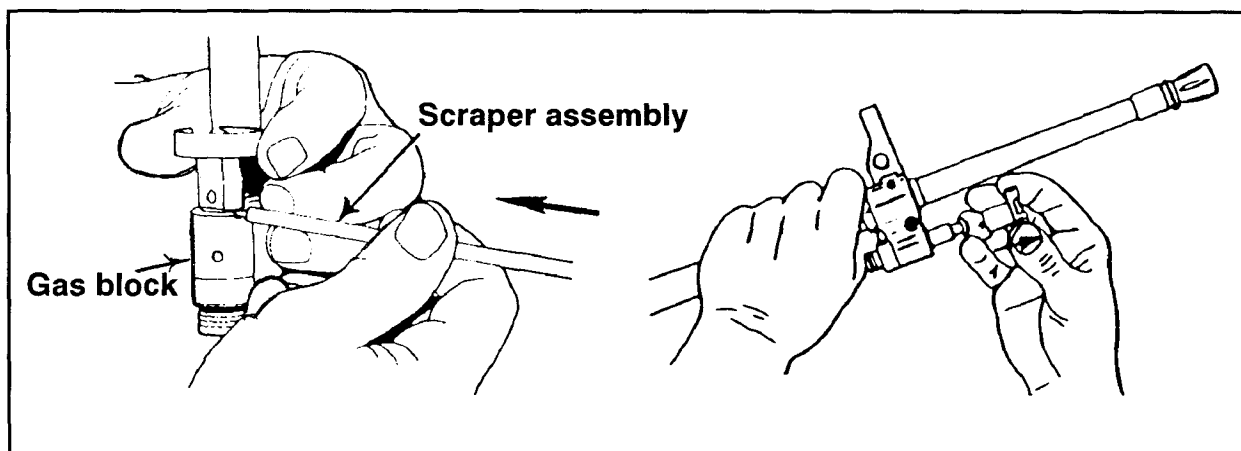

Figure 2-6. Removing the collar.

(4) To remove the gas regulator (Figure 2-7), separate it from the gas block.

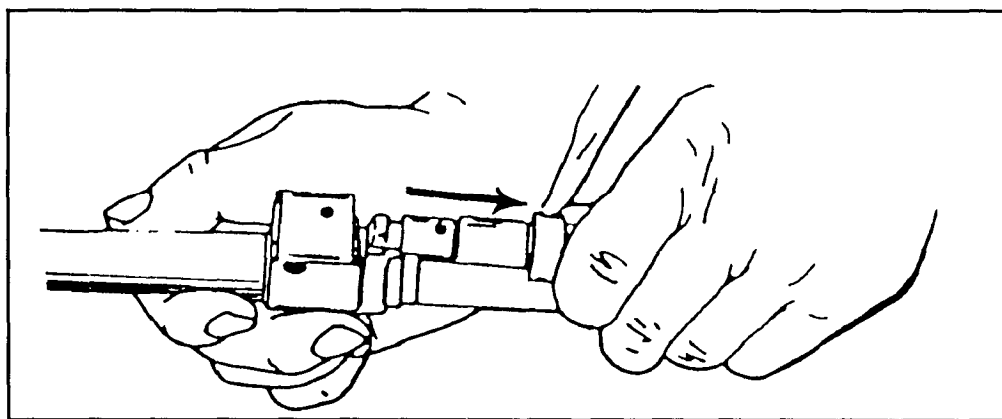

Figure 2-7. Removing the gas regulator.

c. **Removing the Handguard Group (Figure 2-8).** The handguard group consists of the handguard, handguard retaining pin, and cleaning equipment retaining clip. Push the handguard retaining pin to the left using a cartridge or the spring guide rod; then pull the handguard down.

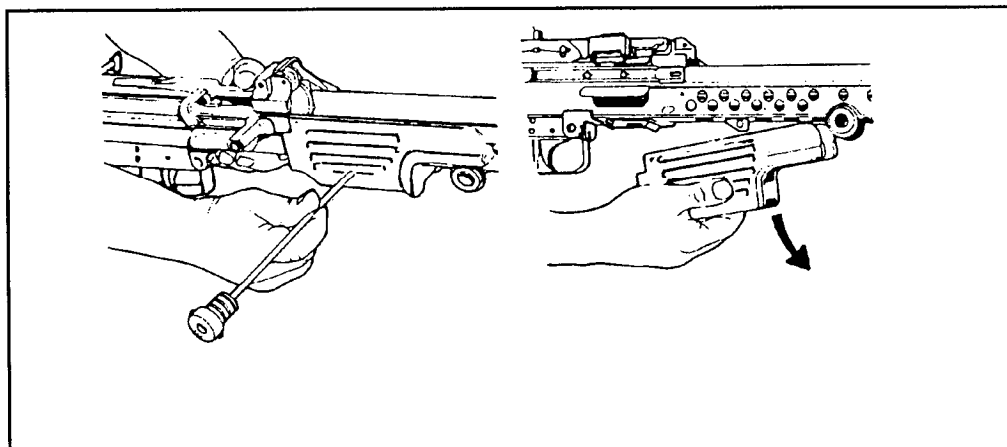

Figure 2-8. Removing the handguard.

CAUTION

The handguard retaining pin is a captured pin. Do not attempt to remove it completely.

d. **Removing the Buttstock and Buffer Assembly Group.** To remove the buttstock and buffer assembly (Figure 2-9), use a cartridge or the spring guide rod to push the lowermost retaining pin on the rear of the receiver to the left. It is a captured pin; it is not removed. Remove the buttstock and shoulder assembly by pulling it rearward, while supporting the trigger mechanism.

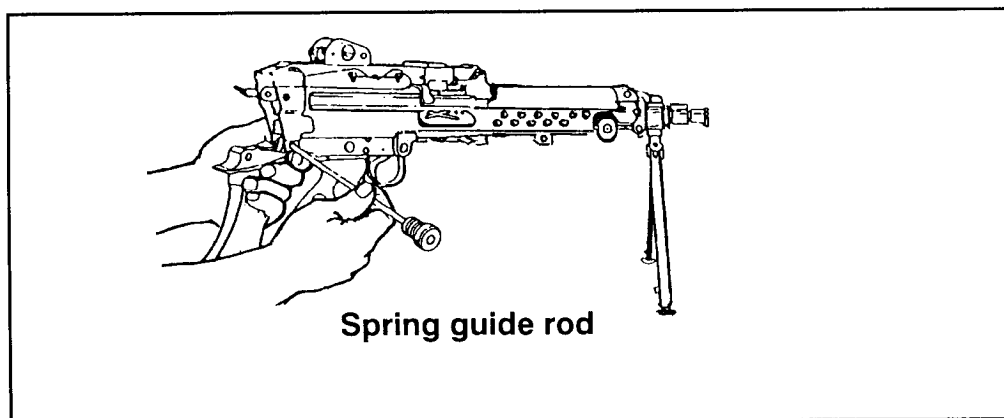

Figure 2-9. Removing the buttstock and buffer assembly.

e. **Removing the Trigger Mechanism Group.** To separate the trigger group, push in on the lowermost retaining pin.

CAUTION

The upper and lower retaining pins in the rear of the receiver are captured pins. Do not attempt to remove them completely.

f. **Removing the Gas Cylinder Group.** To remove the gas cylinder from the receiver (Figure 2-10), grasp the gas cylinder at the top of the bipod legs, turn it to the left or right to release the locking spring, and then pull it away from receiver.

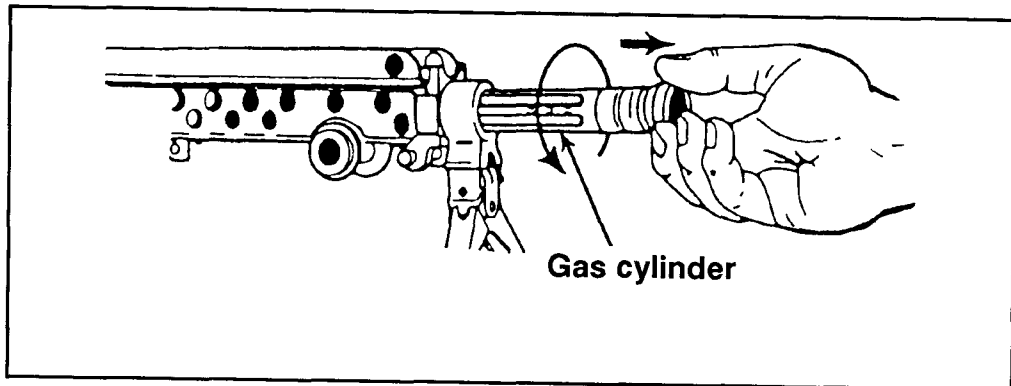

Figure 2-10. Removing the gas cylinder group.

g. **Removing the Bipod Group.** Once the gas cylinder is removed, remove the bipod group (Figure 2-11) by pulling it away from the receiver.

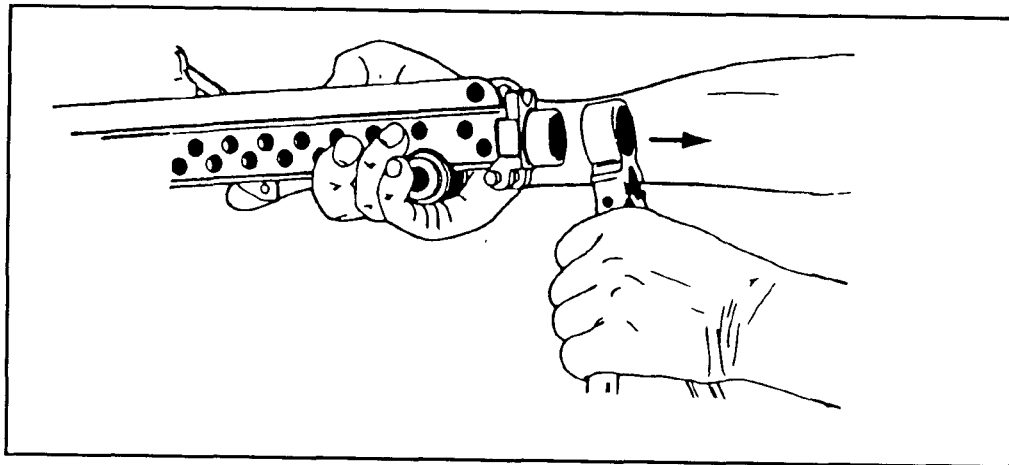

Figure 2-11. Removing the bipod group.

h. **Removing the Receiver Group.** Once the bipod group is removed, the part remaining is the receiver group, and disassembly is complete.

2-3. INSPECTION

Inspection begins with the weapon disassembled in its major groups. Shiny surfaces do not mean the parts are unserviceable. The following parts of the weapon and related equipment are inspected for the conditions indicated. Any broken or missing parts should be repaired *or* replaced IAW TM 9-1005-201-10.

a. **Operating Rod Group.** The operating rod should not be bent, broken, or cracked. The buffer spring should not have breaks. Lug pins should protrude equally on both sides of the buffer spacer. The operating rod spring should not have kinks or separated strands or broken strands. It can have a maximum of one break on any one strand.

(1) The bolt assembly is checked for visible damage. The cartridge extractor should not be cracked or chipped.

(2) The slide assembly is checked for visible damage. The feed roller is checked for spring tension when compressed and that the pivot slide is locked onto the slide assembly.

(3) The firing pin is checked for straightness and cracks and that the tip is completely rounded.

(4) The firing pin spring should not be crushed or bent. The beveled end should not be stretched.

(5) The sear notch on the piston assembly is checked for signs of excessive wear or burring. Slight rotation of the piston on its housing is normal and is not cause for rejection.

b. **Barrel Group.** The flash suppressor should not be cracked, and it should be fastened securely. The front sight post and front sight base must not be bent, cracked, or broken. Weapons already zeroed should not be adjusted. The heat shield assembly is inspected for damage, cracks, or broken retaining clamps. The gas regulator and collar are checked for cracks or burrs. The barrel is checked for bulges, cracks, bends, obstructions, or pits in the chamber or bore. The gas plug is checked for obstructions, cracks, and bulges. The carrying handle is checked to ensure it is not cracked, broken, or missing; that it can be folded under spring pressure to the right and left; and that it remains locked in an upright position.

c. **Handguard Group.** The handguard should not be cracked or broken. The retaining clip must be attached to the handguard retaining pin.

d. **Buttstock and Buffer Assembly Group.** The buttstock is checked for cracks, bends, or breaks; and for missing components. It is checked for linkage and tension on the buffer rod. The shoulder rest is checked to ensure it is not bent or broken and that it locks in both positions.

e. **Trigger Mechanism Group.** The shoulder of the sear should not show excessive wear. The safety should function properly. (The sear should move

only slightly when the safety is on SAFE, and freely when the safety is on FIRE.) The sear pin should not protrude from the trigger mechanism, because the trigger mechanism will not go back in place.

f. **Gas Cylinder Group.** The gas cylinder should not be cracked, bent, or broken.

g. **Bipod Group.** The bipod group should not be cracked, bent, or broken. The bipod legs should extend and collapse easily.

h. **Receiver Group.** The cover latch should work properly. All parts inside the cover assembly should move under spring tension. All spotwelds are checked for cracks. The cover assembly should remain open without support. The belt-holding pawl must be under spring tension. The receiver should not be bent or cracked. The cocking handle should slide freely within its guide and lock in its forward position. The windage and elevation knobs on the rear sight should be movable and legible. The windage scale screws should not be worn or burred.

2-4. CLEANING, LUBRICATION, AND PREVENTIVE MAINTENANCE

The M249 AR should be cleaned immediately after firing. It should be disassembled into its major groups before cleaning. After it has been cleaned and wiped dry, a thin coat of CLP is applied by rubbing with a cloth. This lubricates and preserves the exposed metal parts during all normal temperature ranges. When not in use, the M249 AR should be inspected weekly and cleaned and lubricated when necessary.

a. **Cleaning.** All metal components and surfaces that have been exposed to powder fouling should be cleaned using CLP on a bore-cleaning patch. The same procedure is used to clean the receiver.

CAUTION

When using CLP, no other type cleaner can be used. Never mix CLP with RBC or LSA.

- (1) Clear and disassemble the weapon.
- (2) Clean the bore and chamber using CLP and fresh swabs.
- (3) Clean the gas regulator with the special tool (scraper). Remove all carbon dust. Do not use CLP on the collar, gas block, or body.

(a) Clean the gas vent hole (Figure 2-12).

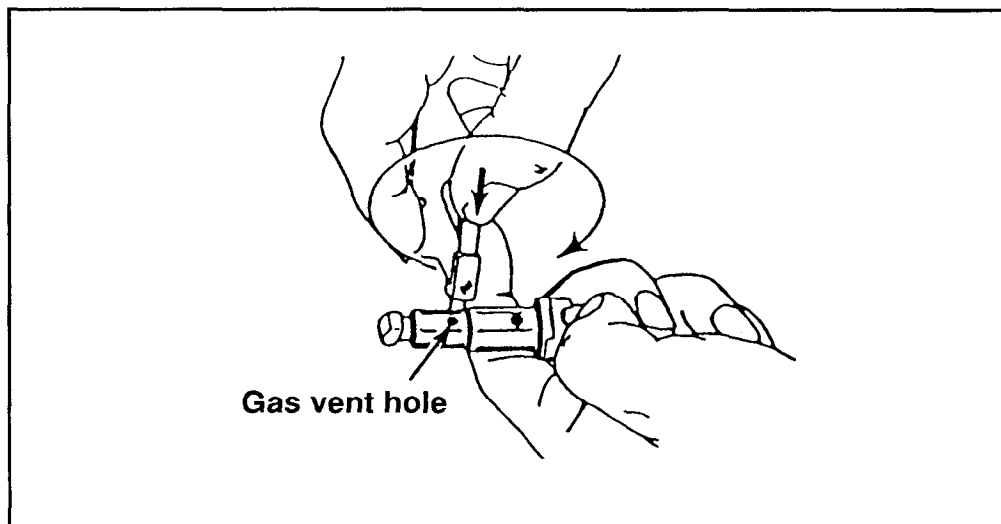

Figure 2-12. Cleaning the gas vent hole.

(b) Clean the central hole with the appropriate part of the scraper by turning it clockwise and pushing it inward toward the bottom of the housing (Figure 2-13).

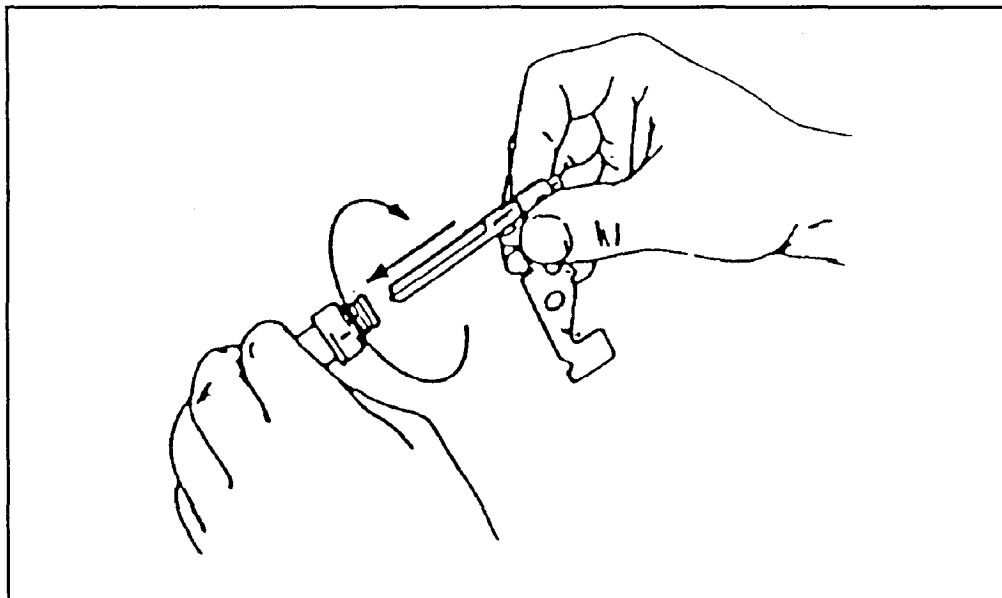

Figure 2-13. Cleaning the central hole.

(c) Use the protruding tips of the scraper to clean the two grooves of the body (Figure 2-14, page 2-14).

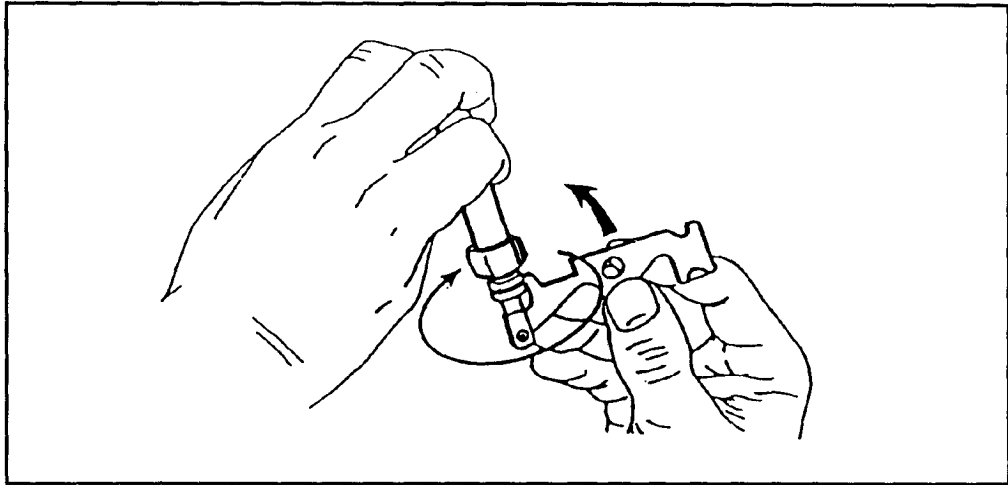

Figure 2-14. Cleaning the grooves of the body.

(4) Clean the gas cylinder and piston with the special tool (scraper). Do not use CLP on the gas cylinder or piston.

(a) Clean the front interior of the gas cylinder (repositioned in receiver with bipod in place) by inserting and turning the flat side of the scraper in a 360-degree circular motion (Figure 2-15).

(b) Clean the internal grooves of the front side of the gas cylinder the same as in paragraph (a) above, except insert the scraper farther into the gas cylinder (Figure 2-15).

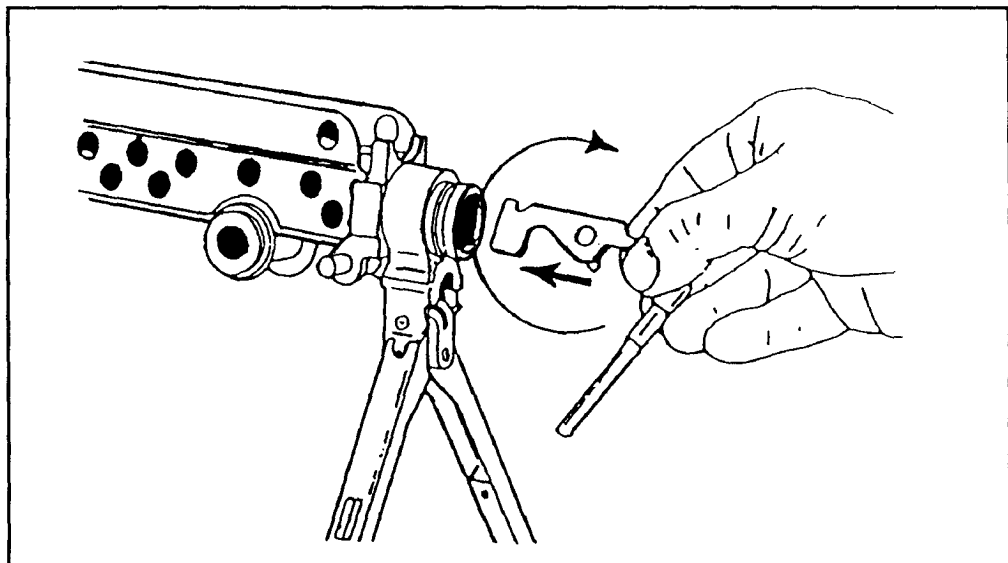

Figure 2-15. Cleaning the front interior and internal grooves of the gas cylinder.

(c) Clean the three grooves of the piston using a 360-degree circular motion (Figure 2-16). Remove **all** carbon dust from the piston inside and out.

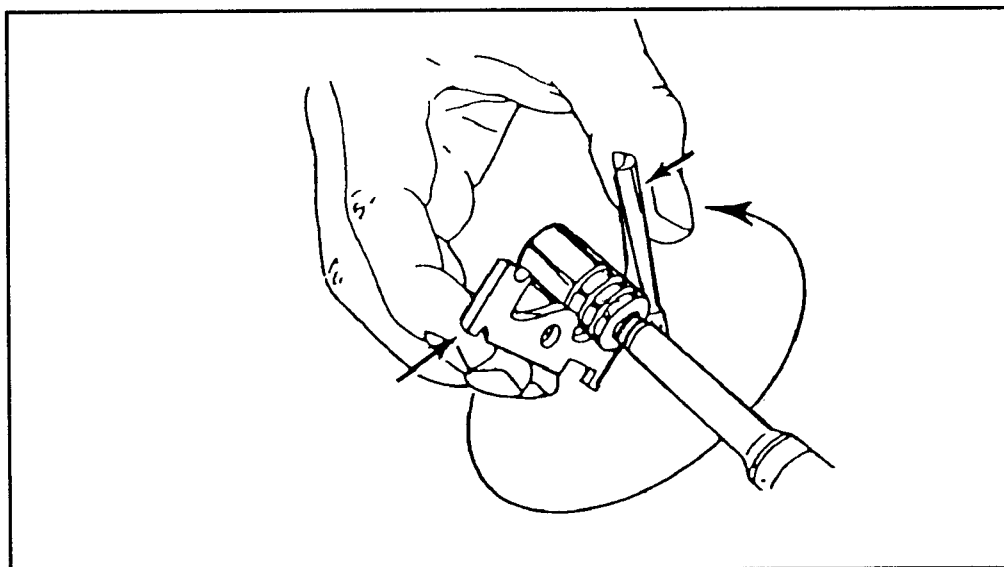

Figure 2-16. Cleaning the grooves of the piston.

(d) Clean the hole in the front of the piston by inserting and turning the flat side of the scraper in a 360-degree circular motion (Figure 2-17).

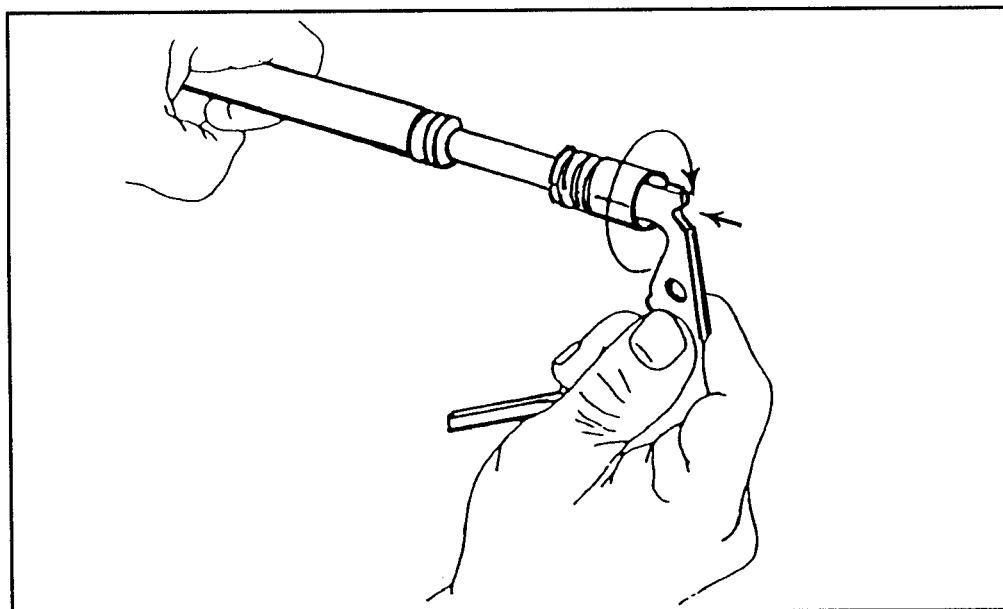

Figure 2-17. Cleaning the hole in the front of the piston.

(5) Clean carbon and dirt from all other parts of the weapon.

NOTE: A cloth saturated in CLP is used on exterior surfaces to prevent corrosion.

b. **Lubrication.** After the M249 AR is cleaned and wiped dry, a thin coat of CLP is applied by rubbing it with a cloth. This lubricates and preserves the exposed metal parts during all normal temperature ranges. The moving parts are lubricated with CLP. After lubricating, rub the components by hand to spread the CLP.

(1) *Operating rod group.* Use CLP on the operating rod and spring, the slide assembly, the feed roller, and the bolt-locking lug.

(2) *Barrel group.* Use CLP on the cam surfaces of the bolt-locking lugs, the heat shield, and along the outer surfaces of the barrel clamp.

(3) *Receiver group.* Use CLP on all moving parts on the cover assembly and the receiver rails.

c. **Preventive Maintenance.** Weapons that are seldom fired or stored for prolonged periods should have a light film of CLP applied to the interior of the gas plug, the gas regulator, and the piston immediately after cleaning or after inspection. Preventive maintenance is performed every 90 days unless inspection reveals more frequent servicing is necessary. The use of the lubricant does not eliminate the need for cleaning and inspecting to ensure that corrosion has not formed. The gas regulator, gas plug, and piston must be clean and free of oil and lubricants before using the weapon. If not cleaned and oil free, stoppages will occur. The following procedures apply to cleaning and lubricating the M249 AR during unusual conditions:

NOTE: CLP is the only lubricant to use on the M249 AR.

(1) Extremely hot—use CLP, grade 2.

(2) Damp or salty air—use CLP, grade 2. Clean and apply frequently.

(3) Sandy or dusty areas—use CLP, grade 2. Clean and apply frequently. Remove excess with a rag after each application.

(4) Below -18 degrees Celsius (0 degrees Fahrenheit)—use CLP, grade 2, generously. Lubricate heavily enough so that it can be spread with finger.

NOTE: Although CLP provides required lubrication at temperatures between 0 degrees Fahrenheit and -35 degrees Fahrenheit, it will not flow from a 1/2-ounce bottle at temperatures below 0 degrees Fahrenheit.

2-5. GENERAL ASSEMBLY

The M249 AR is assembled in reverse order of the disassembly.

a. **Replacing the Receiver Group and Bipod Group.** Place the bipod group on the receiver group with the bipod legs open and pointed downward. (See Figure 2-11.)

b. **Replacing the Gas Cylinder Group.** Push the gas cylinder through the bipod yoke into the receiver. Push the cylinder to the rear while countering the pressure of the locking spring and guiding the end of the cylinder into the receiver with the other hand applying downward pressure. Position the recess in the cylinder near the spring. Turn the cylinder until the spring clicks into the recess at the rear of the gas cylinder (Figure 2-18).

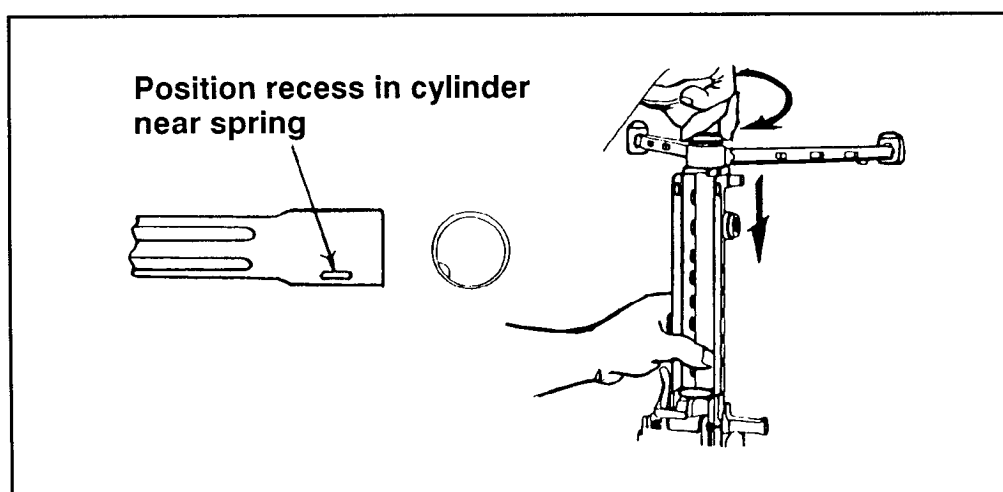

Figure 2-18. Replacing gas cylinder group.

c. **Replacing the Trigger Mechanism Group.** Align the trigger mechanism with the slot on the bottom of the receiver. Hold the trigger mechanism in position to accomplish the next step. (Figure 2-19.)

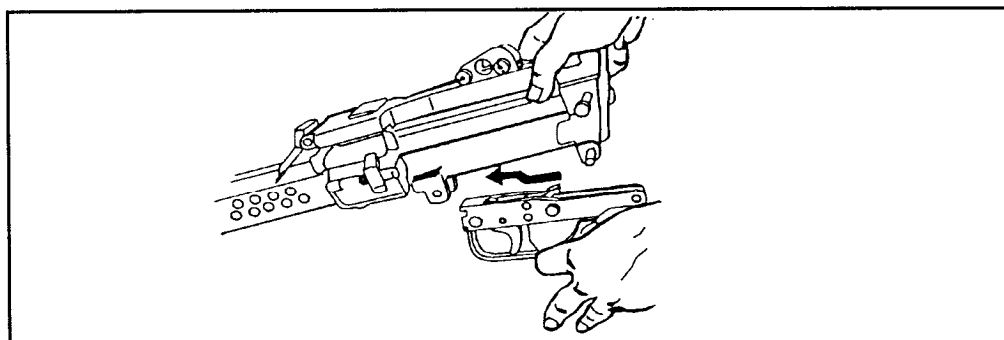

Figure 2-19. Replacing the trigger mechanism group.

d. **Replacing the Buttstock and Buffer Assembly Group.** Align the lower hole in the buttstock and buffer assembly with the rear hole in the trigger mechanism; then push the lower retaining pin to the right. (Figure 2-20.)

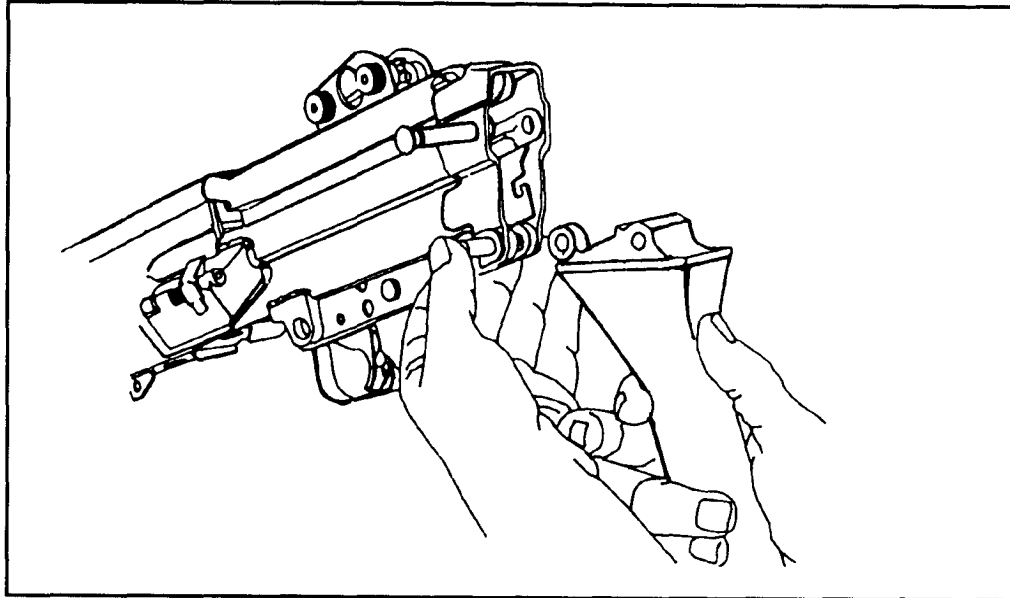

Figure 2-20. Replacing the buttstock and buffer assembly group.

e. **Replacing the Handguard Group.** To replace the handguard, place it on the receiver from the bottom and push it to the rear until it stops. Using the guide rod, push the handguard retaining pin to the right, which locks the handguard into position. Push the handguard down to make sure it is locked. (See Figure 2-8, page 2-9.)

f. **Replacing the Barrel Group.** Insert the gas regulator into the gas block and align the notch on the gas regulator with the notch of the gas block. With the gas regulator installed and supported on a firm surface, place the gas regulator collar onto the protruding end of the body and align the spring with the stud. Push the gas regulator collar downward firmly and rotate it until it slips into place. Then, press it in and rotate it to lock it in place. Depress the barrel locking lever to the rear with your left hand, while holding the carrying handle with your right hand. Pull the barrel rearward and push downward; align the gas regulator with the gas cylinder and lock it by releasing the barrel locking lever. Check the barrel to ensure it is locked into the receiver by pulling or lifting on the carrying handle. Replace the heat shield by placing the hook end of the heat shield under the front sight post and press down until the clamps lock on the barrel. (Figure 2-21.)

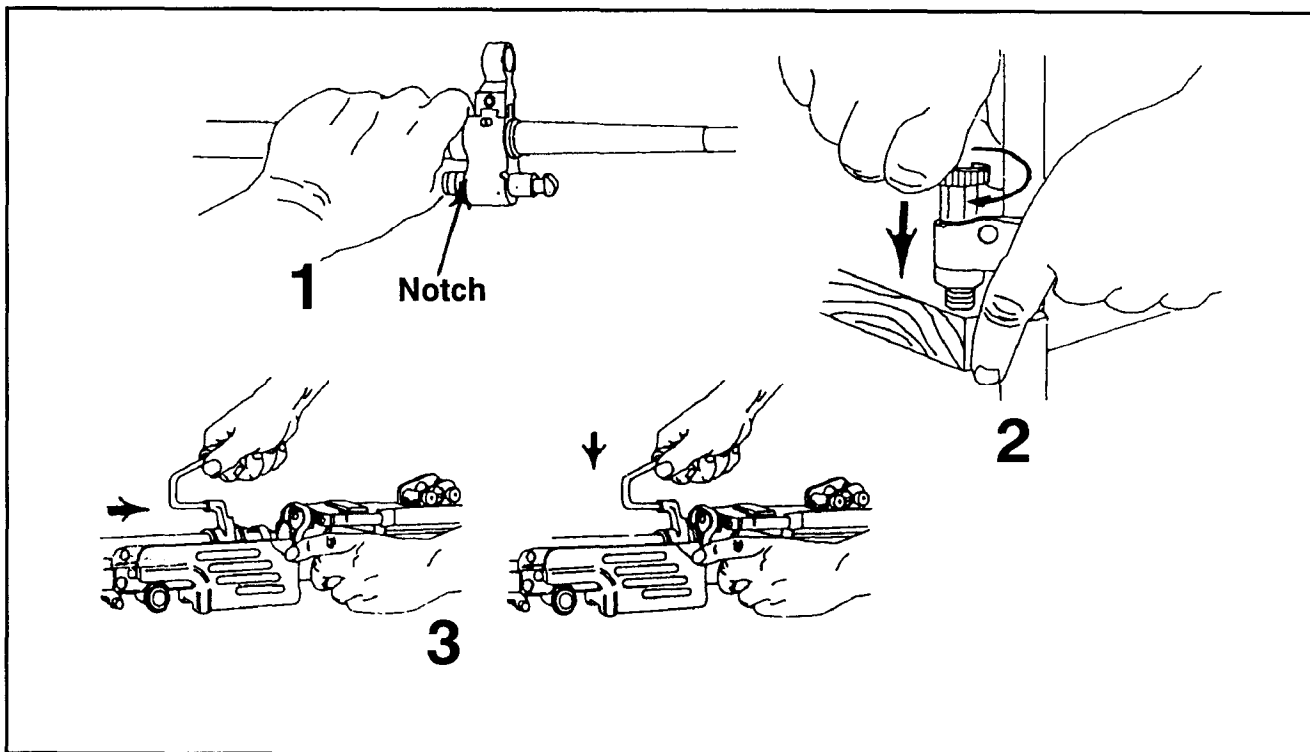

Figure 2-21. Replace the barrel group.

g. Replacing the Operating Rod Group. Hold the piston in one hand with the face of the piston facing outward and the sear notches downward. With the other hand, place the slide assembly onto the rear of the piston with the firing pin toward the front of the piston. (Check the slide assembly retaining pin to make sure it is out.) (Figure 2-22, page 2-20.)

(1) Push the slide assembly retaining pin to the right. This locks the piston assembly and the slide assembly together.

(2) Put the firing pin spring on the firing pin of the slide assembly. Place the bolt on the slide assembly, aligning the driving lug of the bolt with the slot of the slide assembly. Apply pressure to the face of the bolt to compress the firing pin spring. Then, rotate the bolt to hook the driving lug into the slide assembly. Open the cover assembly on the receiver. Insert the face of the piston into the receiver, aligning the bolt lugs onto the receiver rails. Pull the trigger and push the moving parts forward until the bolt is seated into the chamber.

(3) Place the operating rod tip into the operating rod spring. Then, insert the free end of the operating rod and spring into the rear of the piston. Depress the rear of the operating rod assembly until the two lugs on the buffer are positioned in the receiver grooves.

(4) Pivot the buttstock upward into position and push the upper retaining pin to the right, locking the buttstock to the receiver.

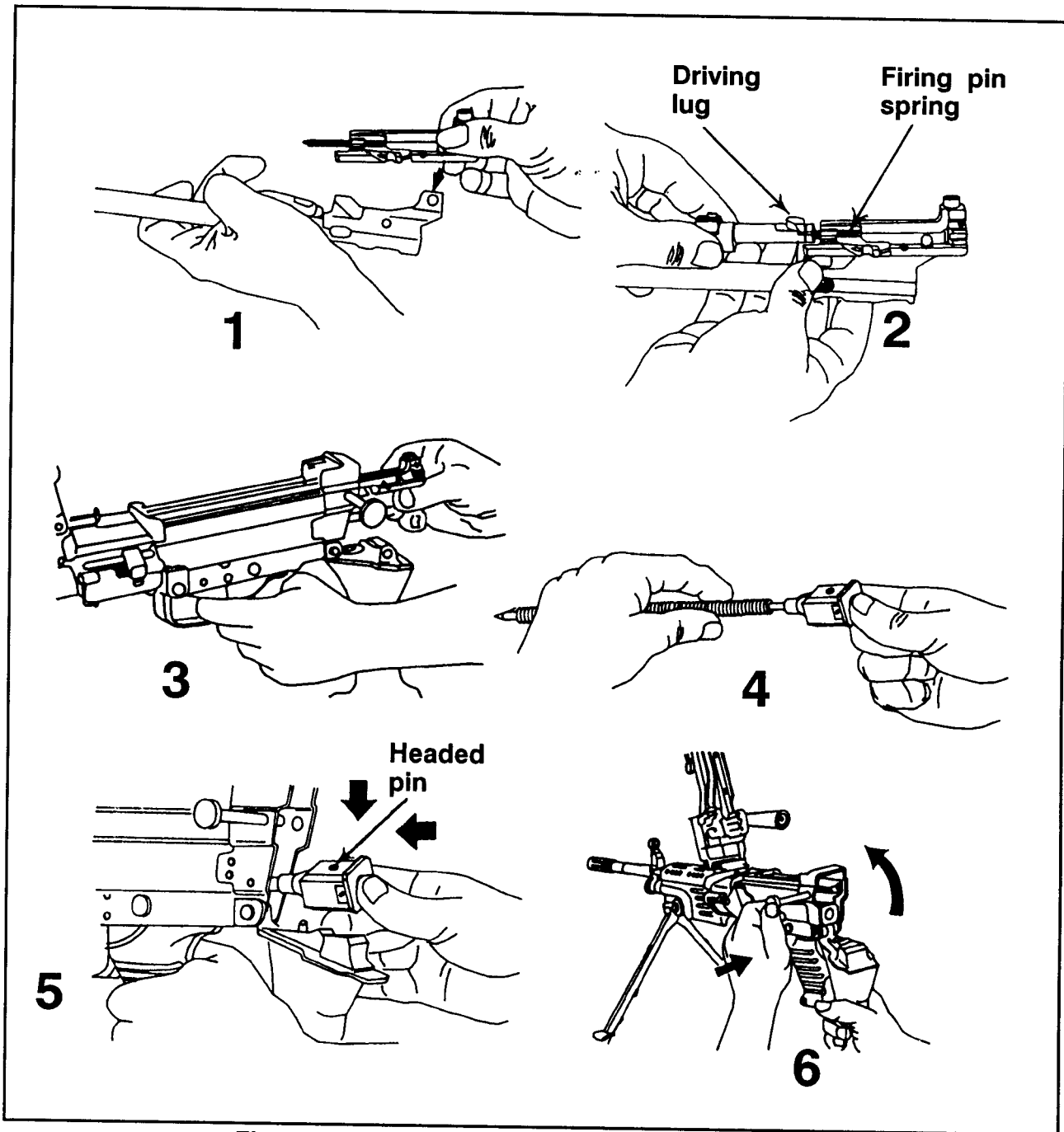

Figure 2-22. Replacing the operating rod group.

2-6. FUNCTION CHECK

A function check must be performed to ensure that the M249 AR has been assembled correctly. The procedures, in order, are—

- Grasp the cocking handle with the right hand, palm up, and pull the bolt to the rear locking it in place.
- While continuing to hold the resistance on the cocking handle, use the left hand to move the safety to the SAFE position.
- Push the cocking handle forward into the forward lock position.
- Pull the trigger. (The weapon should not fire.)
- Grasp the cocking handle with the right hand, palm up, and pull and hold it to the rear.
- Move the safety to the FIRE position.
- While continuing to hold resistance on the cocking handle, use the left hand to pull the trigger and ease the bolt forward to prevent it from slamming into the chamber area and damaging the face of the bolt.
- If the weapon fails the function check, check for missing parts or the reassembly procedures. (Before disassembling the weapon, make sure it is positioned where the guide rod and spring cannot cause bodily harm if the bolt is locked to the rear.)

CAUTION

The bolt must be eased forward to prevent damage to the cover and feed mechanism assembly and operating rod group.

NOTE: The cover and feed mechanism assembly can be closed with the bolt in either the forward or the rearward position.

2-7. MAINTENANCE PROCEDURES

There are certain actions that must be taken before, during, and after firing to properly maintain the M249 AR.

a. Before firing—

- Wipe the bore dry.
- Inspect the weapon as outlined in the operator's TM.
- Lubricate the weapon.

b. **During firing**—

- Inspect the weapon periodically to ensure that it remains lubricated.
- When malfunctions or stoppages occur, follow the procedures in Chapter 4.

c. **After firing**—

- Immediately clear and clean the weapon.
- Every 90 days during inactivity, clean and lubricate the weapon unless inspection reveals more frequent servicing is necessary.

2-8. MAINTENANCE DURING NBC CONDITIONS

If the M249 AR is contaminated by chemical, biological, or radiological agents, appropriate action is taken to reduce exposure and minimize penetration.

a. **Chemical.** Use towelettes from the M258A1 kit to wipe off the weapon. If these are not available, wash the weapon with hot, soapy water and rinse.

b. **Biological.** Use towelettes or hot, soapy water and rinse the weapon as above.

c. **Radiological.** Brush or wipe the weapon, or wash with water and rinse. For more details, see FM 3-5.

CHAPTER 3

OPERATION AND FUNCTION

This chapter discusses the operation of the M249 automatic rifle. This includes loading, unloading, cycle of functioning, adjusting the sight, and using the bipod.

3-1. OPERATION

The M249 AR's operations are loading, firing, unloading, and using belted ammunition or, in an emergency, a 20- or 30-round M16 magazine. The firing operation works on gas pressure created as a fired round passes through the barrel. The M249 is loaded, fired, unloaded, and cleared from the open-bolt position. The safety must be in the FIRE position before the bolt can be pulled to the rear. Before using belted ammunition, it must be checked to ensure it is properly linked with the double link or the link tab at the open end of the box. It must be free of dirt and corrosion. When using a magazine of ammunition, it must be loaded into the magazine well and be free of dirt and corrosion.

3-2. LOADING

To load the M249 AR, make sure the weapon is cleared in accordance with paragraph 2-1. (With the feed cover raised, make sure your face is not exposed to the open chamber area when loading.) (Figure 3-1.)

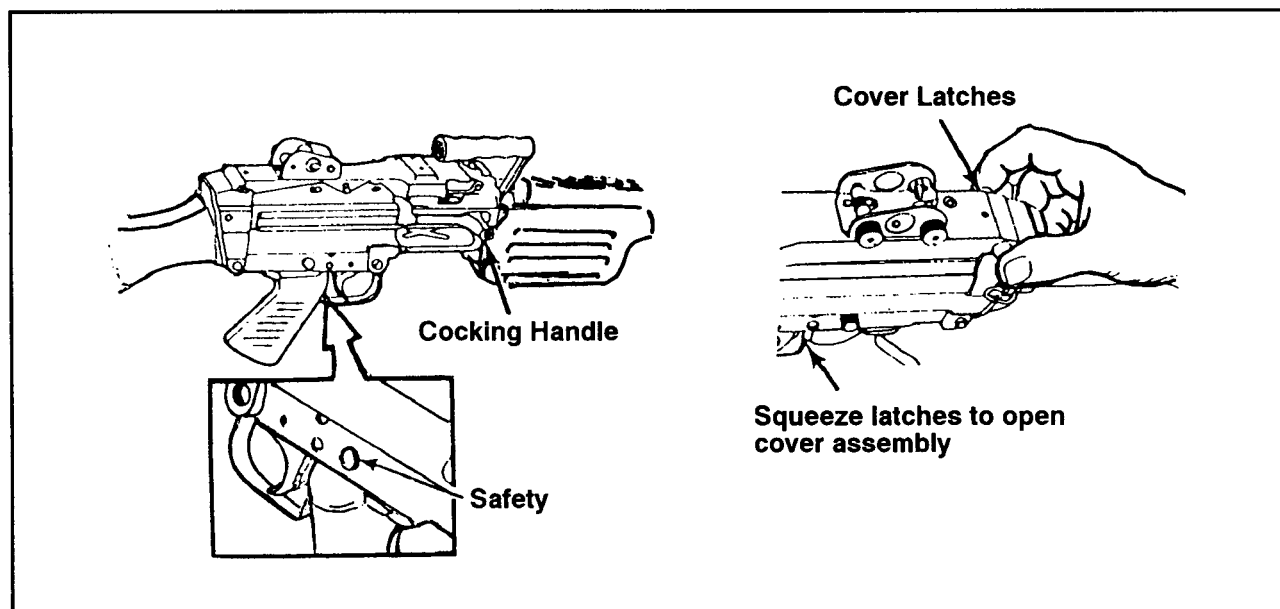

Figure 3-1. Loading.

a. **Belt-Fed.** When loading belted ammunition, always cant the weapon to the right. Make sure the open side of the links is facing down, and place the lead link tab or first round of the belt in the tray groove against the cartridge stop. The rounds should be placed flat across the feed tray. With your left hand, count five to six rounds down to hold ammunition in place on the feed tray, while at the same time close the feed cover with your right hand. When closing the feed cover, always place your hand in front of the rear sight to prevent accidentally changing the sight adjustment.

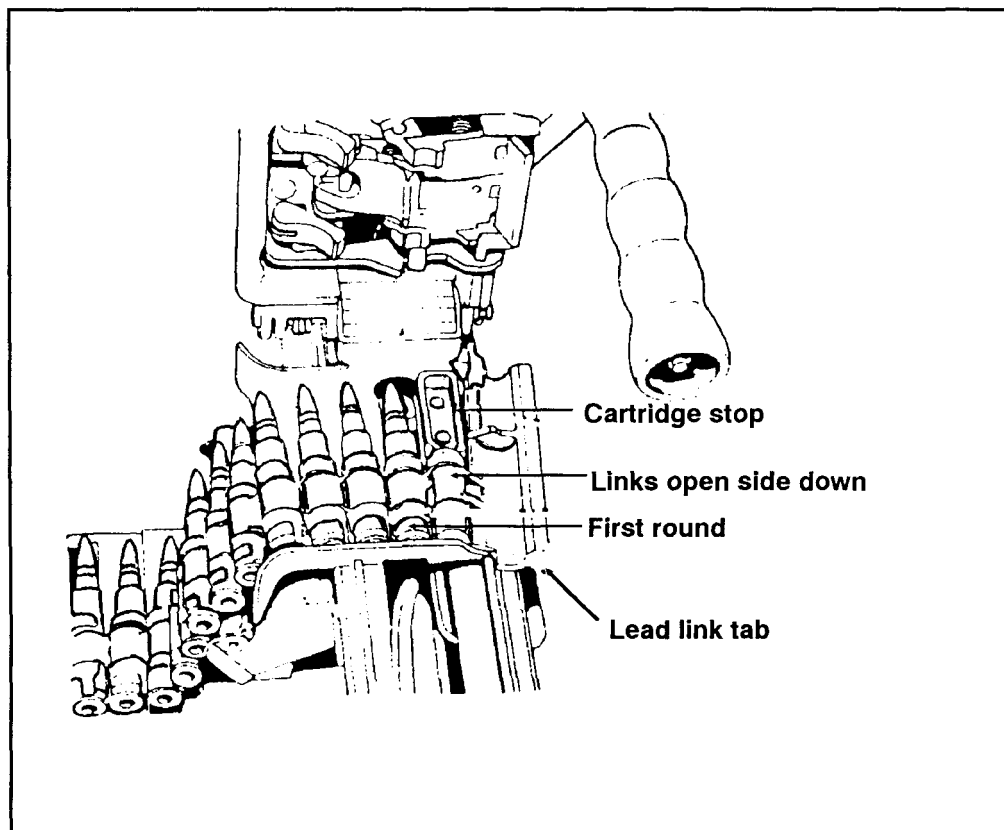

Figure 3-2. Belt-fed.

NOTE: The 20- or 30-round magazine is for emergency use only when linked ammunition is not available.

b. **Magazine-Fed.** Load the 20-or 30-round magazine by inserting it into the magazine well on the left side of the receiver. Push the magazine firmly into the well until it seats and the release tab clicks into the recess on the magazine (Figure 3-3).

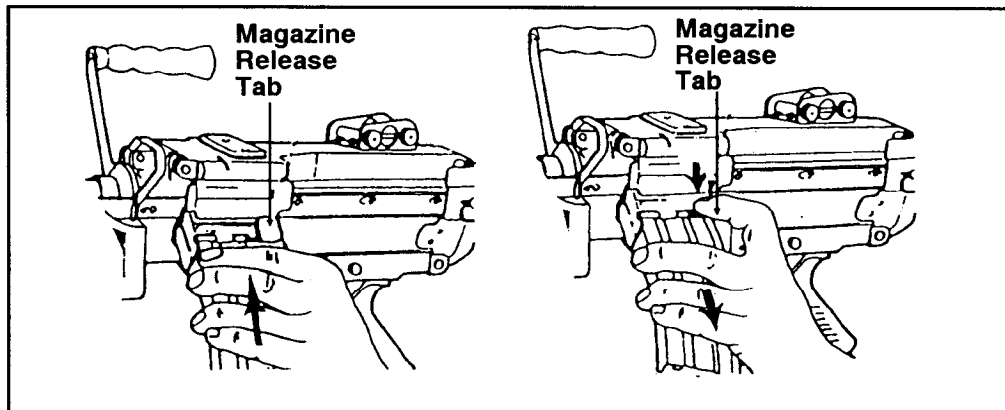

Figure 3-3. Loading a magazine.

3-3. UNLOADING

To unload the weapon, pull the bolt and lock it in the rear position if not already there. Place the safety on SAFE. Depending on whether belt-fed or magazine-fed ammunition is used, use the following procedures.

CAUTION

Before you raise the feed cover, move the weapon away from your face so that you are not exposed to the open chamber.

- a. **Belt-Fed.** Raise the feed cover and remove any ammunition or links from the feed tray. Perform the five-point safety check.
- b. **Magazine-Fed.** Push the magazine release tab down and pull the magazine from the magazine well. Raise the feed cover and perform the five-point safety check.

3-4. CYCLE OF FUNCTIONING

M249 automatic riflemen can recognize and correct stoppages when they know how the weapon functions. The weapon functions automatically as long as ammunition is fed into it and the trigger is held to the rear. Each time a round fires, the parts of the weapon function in a cycle or sequence. Many of the actions occur at the same time. These actions are separated in this manual only for instructional purposes.

- a. The cycle is started by putting the first round of the belt in the tray groove or by inserting the magazine into the magazine well. Then the trigger is pulled, releasing the sear from the sear notch. When the trigger is pulled to the rear, the rear of the sear is lowered and disengaged from the sear notch. This allows the piston and bolt to be driven forward by the expansion

of the operating rod spring. The cycle stops when the trigger is released and the sear again engages the sear notch on the piston.

b. The sequence of functioning is as follows.

(1) *Feeding.* As the bolt starts its forward movement, the feed lever is forced to the right, causing the feed-pawl assembly to turn in the opposite direction. This forces the feed-pawl assembly over the next round in the belt, and it is ready to place the next round into the tray groove when the rearward action occurs again. As the bolt moves to the rear after firing, the feed roller forces the feed lever to the left. The feed lever is forced to turn, moving the feed pawl to the right. This places a round in the tray groove.

(2) *Chambering.* As the bolt travels forward, the upper locking lug engages the rim of the round. The pressure of the front and rear cartridge guides holds the round so that positive contact is made with the upper locking lug of the bolt. The front cartridge guide prevents forward movement of the link as the round is stripped from the belt. The upper locking lug carries the round forward. The chambering ramp causes the nose of the round to be cammed downward into the chamber. When the round is fully seated in the chamber, the extractor snaps over the rim of the round, and the ejector on the rail inside the receiver is depressed.

(3) *Locking.* As the round is chambered, the bolt enters the barrel socket. The upper and lower locking lugs contact the bolt camming surfaces inside the barrel and start turning the bolt clockwise. The action of the bolt into the slide assembly, as the piston continues forward, turns the bolt to complete its 90-degree (one-quarter turn) clockwise rotation. Locking is now complete.

(4) *Firing.* After the bolt is fully forward and locked, the piston continues to go forward, independent of the bolt, for a short distance. The slide assembly carries the firing pin through the face of the bolt. The firing pin strikes the primer of the round and the primer fires the round.

(5) *Unlocking.* After the round is fired and the bullet passes the gas port, part of the expanding gases go into the gas regulator through the gas plug. The rapidly expanding gases enter into the gas cylinder from the gas regulator, forcing the piston to the rear. As the piston continues to the rear, the slide assembly, also moving to the rear, causes the bolt to begin its counterclockwise rotation. The upper and lower locking lugs of the bolt contact the bolt camming surfaces inside the barrel socket and, as the bolt continues toward the rear, it completes a one-quarter turn counterclockwise. The rotation and movement to the rear unlocks the bolt from the barrel socket.

(6) *Extracting.* Extracting begins during the unlocking cycle. The rotation of the bolt loosens the cartridge case in the chamber. As the piston and bolt move to the rear, the extractor pulls the cartridge case from the chamber.

(7) *Ejecting.* As the cartridge case is pulled from the chamber, the bolt passes by the ejector. This causes the ejector clip to expand, forcing the ejector to push the expended cartridge. The extractor grips the right side of the cartridge and causes it to spin from the weapon as it reaches the ejection port. The empty belt links are forced out the link ejection port as the rearward movement of the bolt causes the next round to be positioned in the tray groove.

(8) *Cocking.* The piston assembly acts against the firing pin, pulling the firing pin from the primer of the spent cartridge case. The action of the piston assembly, continuing to the rear with the firing pin, releases the compression of the firing pin spring. As long as the trigger is held to the rear, the M249 AR will continue to complete the eight steps of functioning automatically. When the trigger is released and the sear again engages the sear notch, the cycle of functioning is stopped and the weapon is cocked. To prevent undue wear to the sear and sear notch, the automatic rifleman must hold the trigger firmly to the rear during firing.

3-5. SIGHT SETTINGS AND CORRECTIONS

This paragraph provides information on how to set the sights for elevation and windage for the M249 AR. It also includes information on how to make corrections if the initial setting on the windage knob or peep sight is not accurate. At a 10-meter target, each paster is 1 cm. Therefore, two clicks on the windage knob in either direction moves the strike of the round left or right 1 cm and two turns on the peep sight moves the strike of the round up or down 1 cm. For example: If the shot group was 2 cm above and 1 cm to the right of the paster, sight corrections are made by correcting windage first. In this case, rotate the windage knob two clicks toward the buttstock (clockwise). Rotate elevation knob four turns toward the buttstock (clockwise) to lower the strike of the round. (Figure 3-4, page 3-6).

a. **Elevation.** Adjustments for elevation (range) require the automatic rifleman to turn the elevation knob (closest to the buttstock) on the rear sight to the desired range setting. Range settings are graduated increments from 300 to 1,000 meters. Even numbered settings are on the left side of the scale wheel and are numbered 4, 6, 8, 10 which represent 400, 600, 800, and 1,000 meters, respectively. Odd numbered settings are on the right side of the scale wheel and marked with the number 3 and three index lines, which represent 300, 500, 700, 900 meters, respectively. Rotation of the elevation knob toward the muzzle (counterclockwise) increases the range, while rotation toward the buttstock (clockwise) decreases the range. Fine adjustments, like zeroing, are made by adjusting the peep sight. Each 180-degree turn equals

a $\frac{1}{2}$ -mil change in elevation which equals a $\frac{1}{2}$ -cm change in impact at a range of 10 meters. Clockwise (to the right) rotations decrease elevation, while counterclockwise (to the left) rotations increase elevation. The peep sight can be turned nine 180-degree turns from top to bottom. To make the peep sight easier to grasp, the elevation knob is turned to its highest point (1,000 meters). The appropriate adjustment is made for the peep sight, and then the sight is returned to the desired range. Whenever readjusting the range, the point of aim is never changed. The point of aim is the center base of the target.

b. **Windage.** Adjustments for windage are made by traversing the rear sight right and left along the sliding scale. The sliding scale is marked or graduated with index lines. Each index line is equal to $\frac{1}{2}$ -mil change in direction or $\frac{1}{2}$ -cm change of impact at 10 meters. Rotation of the windage knob (closest to the muzzle end) toward the muzzle (counterclockwise) moves the rear sight aperture right, which moves the strike of the rounds right; while rotation toward the buttstock (clockwise) moves the aperture left, which moves the strike of the rounds left.

c. **Corrections.** One click of the windage knob or peep sight moves the strike of the round $\frac{1}{2}$ cm at a range of 10 meters or $\frac{1}{2}$ meter at 1,000 meters. To make corrections, Table 3-1 is used as a reference.

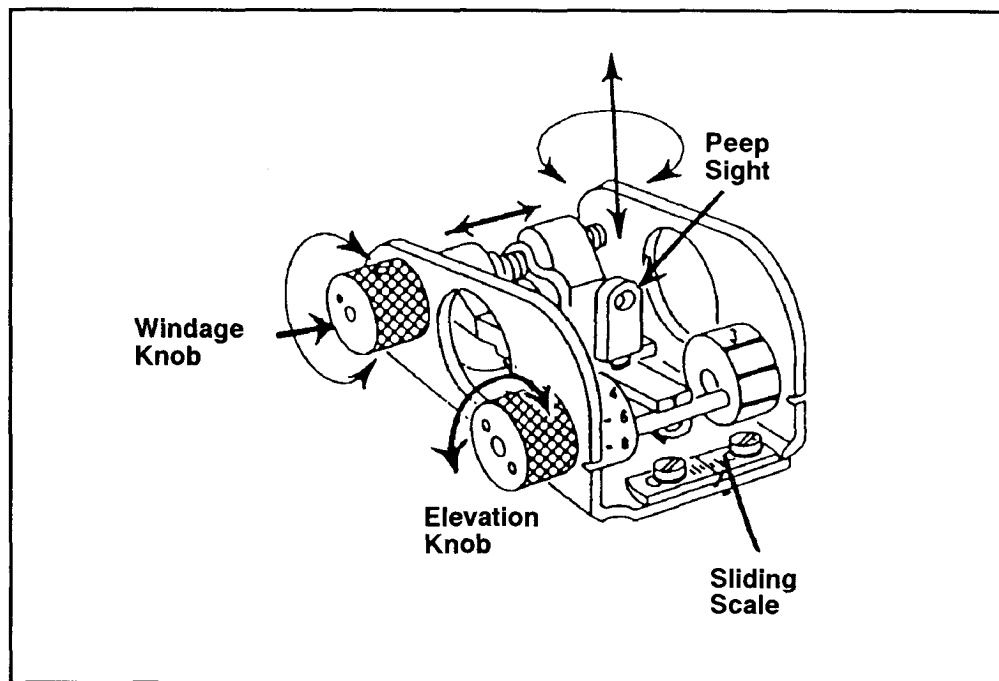

Figure 3-4. Sliding scale on sight.

100 meters - one click moves strike	5 cm (2 inches).
200 meters - one click moves strike	10 cm (4 inches).
300 meters - one click moves strike	15 cm (6 inches).
400 meters - one click moves strike	20 cm (8 inches).
500 meters - one click moves strike	25 cm (10 inches).
600 meters - one click moves strike	30 cm (12 inches).
700 meters - one click moves strike	35 cm (14 inches).
800 meters - one click moves strike	40 cm (16 inches).
900 meters - one click moves strike	45 cm (18 inches).

Table 3-1. Windage and elevation (peep sight) correction chart.

3-6. BIPOD POSITIONING

The bipod group is used to fire from the prone position. The shoulder rest on the buttstock provides support for the AR when fired in the bipod mode. The gas cylinder group holds the bipod group in place. Once the gas cylinder is removed, the bipod group can also be removed from the receiver.

a. To lower the bipod legs, hold the legs together and pull down and away from the handguard. Release the legs so that they lock in the vertical position. To extend the bipod legs, grasp the foot of each leg and pull down. (Figure 3-5).

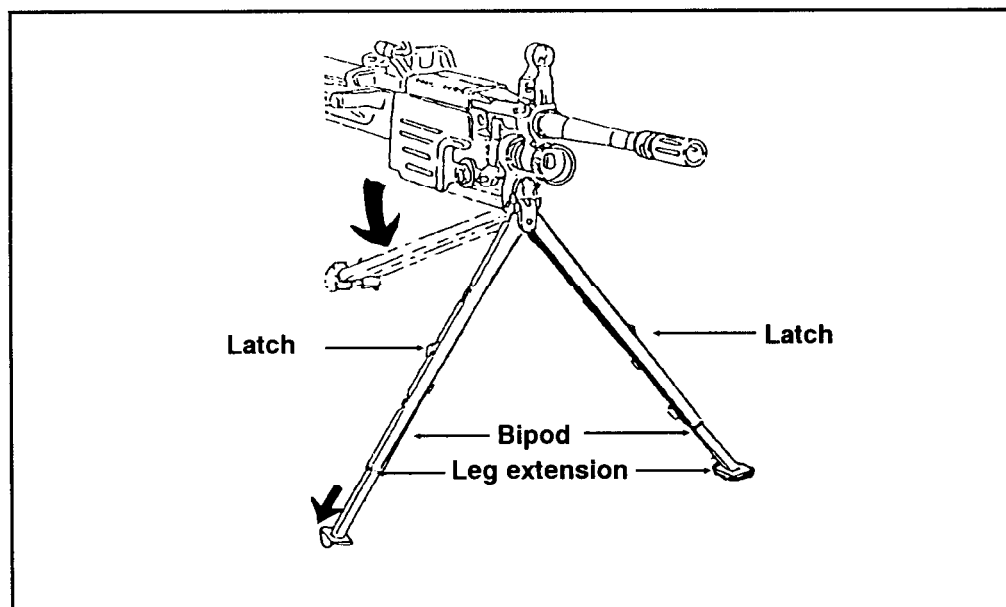

Figure 3-5. Lowering the bipod.

- b. To retract the bipod legs, push in the latches and push in the legs.
- c. Fold the bipod legs when transporting the weapon. Hold the two legs together, pull back under the handguard, and release so that the hooks on the legs grip the handguard. The bipod can be folded only when the legs are in the closed position (Figure 3-6).

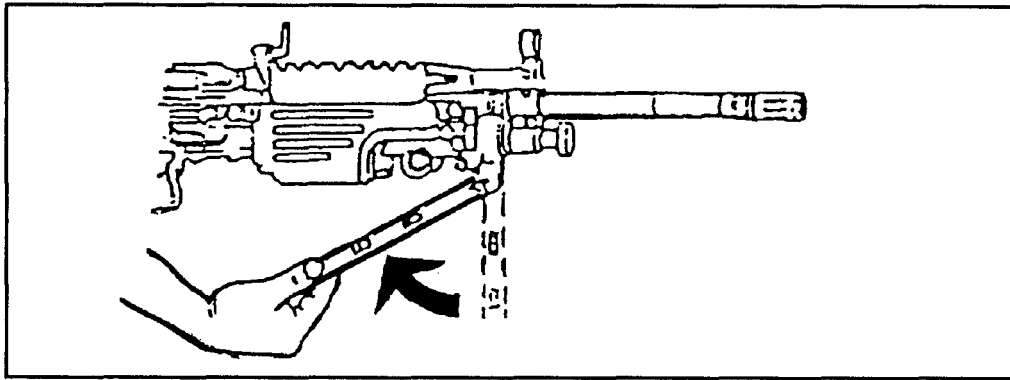

Figure 3-6. Folding of the bipod under the handguard.

CHAPTER 4

PERFORMANCE PROBLEMS AND DESTRUCTION

This chapter identifies some of the problems that cause the weapon to perform improperly. It also explains how to identify unserviceable parts, and how to destroy the M249 when authorized to do so.

4-1. MALFUNCTIONS

A malfunction occurs when a **mechanical failure** causes the **weapon to fire improperly**. Defective ammunition or improper operation by the automatic rifleman is not considered a malfunction. If cleaning and or lubricating the weapon does not fix the problem, then it is turned in to the unit armorer. Table 4-1 shows malfunctions, their probable causes, and the corrective actions.

MALFUNCTION	PROBABLE CAUSE	CORRECTIVE ACTION
<p>Sluggish operation.</p> <p>Failure to cock or a runaway weapon.</p>	Lack of lubricant.	Lubricate.
	Carbon buildup in gas system.	Clean gas regulator, piston, and cylinder.
	Burred parts.	Notify organizational maintenance.
	Broken, worn, or burred sear.	Notify organizational maintenance.
	Piston assembly sear notch worn.	Notify organizational maintenance.
	Sear stuck in trigger housing.	Notify organizational maintenance.
	Short recoil.	Clean and lubricate bolt and slide assembly.
Carbon buildup in gas system.	Clean gas regulator, piston, and cylinder.	

Table 4-1. Malfunctions.

4-2. STOPPAGES

A stoppage is any **interruption** in the cycle of functioning caused by **faulty action** of the weapon or **faulty ammunition**. Stoppages are classified by their relationship to the cycle of functioning. Table 4-2 shows types of interruptions or stoppages, their probable causes, and the corrective actions.

STOPPAGE	PROBABLE CAUSE	CORRECTIVE ACTION
<p>Failure to feed.</p>	<p>Insufficient lubrication. Defective ammunition link. Obstruction in receiver. Insufficient gas pressure. Unlatched cover. Long or short rounds. Inverted link belt. Damaged, weak, or worn operating parts.</p>	<p>Lubricate as required. Remove and replace ammunition. Remove obstruction. Clean gas regulator, piston, and cylinder. Latch cover. Align rounds in link belt. Reinstall link belt with open end of link facing down. Notify organizational maintenance.</p>
<p>Failure to fire.</p>	<p>Safety on. Link belt improperly loaded. Defective ammunition. Faulty ammunition. Broken or damaged firing pin. Broken or weak driving spring.</p>	<p>Push safety to left, exposing red ring. Remove and reinstall link belt properly. Eject round. Replace ammunition. Notify organizational maintenance. Notify organizational maintenance</p>
<p>Failure to extract.</p>	<p>Dirty chamber or bolt and slide assembly. Carbon buildup in gas system Damaged extractor or spring.</p>	<p>Clean chamber or bolt and slide assembly. If problem continues, notify organizational maintenance. Clean gas regulator, cylinder, and piston. Notify organizational maintenance.</p>
<p>Failure to chamber.</p>	<p>Dirty ammunition. Carbon buildup in gas cylinder.</p>	<p>Clean ammunition. Clean gas cylinder.</p>

Table 4-2. Stoppages.

STOPPAGE	PROBABLE CAUSE	CORRECTIVE ACTION
	Carbon buildup in receiver. Damaged round. Damaged or weak driving spring. Dirty chamber. Damaged gas regulator.	Clean receiver. Remove round and recock weapon. Notify organizational maintenance. Clean chamber. Notify organizational maintenance.
Failure to eject.	Short recoil. Damaged ejector or spring. Carbon buildup in gas system.	Clean and lubricate bolt and slide assembly. If problem still exists, notify organizational maintenance. Notify organizational maintenance. Clean gas regulator, piston, and cylinder.

Table 4-2. Stoppages (continued).

4-3. IMMEDIATE ACTION

Immediate action is action taken to **reduce a stoppage without looking for the cause**. Immediate action should be taken in the event of a misfire or a cookoff. A misfire is the failure of a chambered round to fire. Such failure can be due to an ammunition defect or faulty firing mechanism. A cookoff is the firing of a round by the heat of a hot barrel and not by the firing mechanism. Cookoffs can be avoided by applying immediate action within 10 seconds of a failure to fire. The automatic rifleman keeps the AR on his shoulder while performing immediate action procedures. If the M249 stops firing, the following immediate actions are taken. (An effective memory aid is POPP, which stands for Pull, Observe, Push, and Press.)

a. Pull and lock the cocking handle to the rear while observing the ejection port to see if a cartridge case, belt link, or round is ejected. Ensure that the bolt remains to the rear to prevent double feeding if a round or cartridge case is not ejected.

b. If a cartridge case, belt link, or a round is ejected, push the cocking handle to its forward position, take aim on the target, and press the trigger. If the weapon does not fire, take remedial action. If a cartridge case, belt link, or round is not ejected, take remedial action.

DANGER

If nothing is ejected and the barrel is hot (200 or more rounds fired in less than 2 minutes), do not open the cover. Push the safety to the right (red ring not visible), which places the weapon on safe. Keep the weapon pointed downrange and remain clear for 15 minutes, then clear the weapon.

4-4. REMEDIAL ACTION

Remedial action is any action taken to **determine the cause of a stoppage** and to **restore the weapon** to an operational condition. This action is taken only after immediate action did not remedy the problem.

a. **Cold Weapon Procedures.** When a stoppage occurs with a cold weapon and immediate action has failed, use the following procedures.

(1) While the weapon is on your shoulder, grasp the cocking handle with the right hand, palm up, pull the cocking handle to the rear locking the bolt. While holding the resistance on the cocking handle, move the safety to SAFE and return the cocking handle.

(2) Place the weapon on the ground or away from your face and open the feed cover, perform the five-point safety check. Reload and continue to fire.

(3) If it does not fire, clear the weapon and inspect it and the ammunition.

b. **Hot Weapon Procedures.** If the stoppage occurs with a hot weapon (200 or more rounds in less than 2 minutes), move the safety to SAFE, wait 5 seconds (during training, let the weapon cool for 15 minutes), use the same procedures as outlined for cold weapon procedures.

DANGER

Be careful in clearing the weapon when the barrel is hot, a round may fire (cookoff) from the barrel's heat instead of by the firing mechanism. During combat, wait 5 seconds because of the possibility of a "hangfire" before applying remedial action. During training, wait 15 minutes before clearing a hot weapon and applying remedial action.

4-5. DESTRUCTION PROCEDURES

Destruction of any military weapon is only authorized as a last resort to prevent enemy capture or use. This paragraph discusses the field-expedient means of this destruction; it does not replace published policies. In combat

situations, the commander has the authority to destroy weapons, but he must report this destruction through channels.

a. Disassemble the weapon as completely as time permits. Use the barrel to destroy the bolt, operating rod group, biped, sights (rear and front), and receiver.

b. Bury the disassembled weapon or dump the parts into a stream, a sump, or a latrine.

c. Burn the weapon by placing an incendiary grenade on the receiver group over the bolt (with the cover feed mechanism assembly resting on the grenade) and detonating the grenade.

CHAPTER 5

MARKSMANSHIP TRAINING

This chapter is an aid for trainers in preparing and conducting marksmanship training for the M249 in the automatic rifle mode. Marksmanship training is conducted in three phases—preliminary marksmanship; basic marksmanship; and advanced marksmanship, which is combat techniques of fire discussed in Chapter 6.

Section I. INTRODUCTION TO MARKSMANSHIP

Marksmanship begins with nonfiring individual skill proficiency and concludes with collective proficiency firing during demanding conditions.

5-1. OBJECTIVES

The objectives of M249 marksmanship training are to produce soldiers that are capable of the following.

a. **Accurate Initial Burst.** Obtaining an accurate initial burst of fire on the target is essential to good marksmanship. This requires the automatic rifleman to estimate range to the target, set the sights, and apply the fundamentals of marksmanship while engaging targets.

b. **Adjustment of Fire.** The automatic rifleman must observe the strike of the rounds when the initial burst is fired. If not on target, he manipulates the M249 until the rounds do strike the target. He must be proficient in observing the strike of rounds, in observing and using tracers, and in rapidly laying the M249 AR on the target during firing.

c. **Speed.** Speed is also essential to good marksmanship; it is attained by practice in both dry-fire and live-fire exercises. It is an acquired skill gained through extensive training that combines other skills when delivering fire. Speed should not be stressed to the detriment of accuracy.

5-2. TRAINING PHASES

Marksmanship training for the M249 is progressive in nature. It begins with nonfiring individual skill proficiency and concludes with collective proficiency firing during demanding conditions. Soldiers and leaders must master the fundamentals before attempting individual and collective firings. More effective and efficient marksmanship occurs if live firing is preceded with preliminary marksmanship training. Likewise, proficient individual firing will achieve more proficient collective firing.

a. **Preliminary Marksmanship.** In this phase, the soldier learns and demonstrates proficiency on individual skills that prepare him for live fire.

This includes mastering mechanical training, the four fundamentals of marksmanship, sight adjustments, and fire commands. (See Section II.)

b. **Basic Marksmanship.** In this phase, the soldier applies the fundamentals in live-fire exercises during day, night, and NBC conditions. This includes zeroing, 10-meter firing, field zeroing, and transition firing. (See Section III.)

c. **Advanced Marksmanship.** In this phase, the soldier is trained on combat techniques of fire and techniques of employment. (See Chapter 6.)

5-3. TRAINING STRATEGY

Training strategy involves the overall concept for integrating resources into a program to train individual and collective skills that are needed to perform a wartime mission. The goal of a marksmanship program is to produce well-trained marksmen who can win and survive on the battlefield.

a. Leaders implement training strategies for M249 AR marksmanship in TRADOC institutions (IET, NCOES, IOBC, and IOAC) and in units. The overall training strategy is multifaceted and is inclusive of the specific strategies used in institution and unit programs. Also included are the supporting strategies that use resources such as publications, ranges, ammunition, training aids, devices, simulators, and simulations. These strategies focus on developing critical soldier skills and leader skills that are required for the intended outcome.

b. The training strategies contain two components: initial training and sustainment training. Both may include individual and collective skills. Initial training is critical because a task that is taught correctly and learned well is retained longer. When an interim of nonuse occurs, well-trained skills are more quickly regained and sustained. The more difficult and complex the task, the harder it is to sustain the skill. Personnel turnover plays a major factor in the decay of collective skills, since the loss of critical team members requires retraining to regain proficiency. If a long period elapses between initial and sustainment training sessions or training doctrine is altered, retraining becomes necessary.

c. The training strategy for M249 marksmanship begins in the institutions and continues in the unit. Figure 5-1, page 5-4, illustrates an example of this overall process, which provides a concept of the flow of unit sustainment training. Combat arms IET provides field units with soldiers who are familiar with standards in basic marksmanship tasks. The soldiers graduating from these courses have been trained to maintain their M249s and to hit a variety of targets. They have learned range determination, target detection, application of marksmanship fundamentals, and other skills needed to engage a target.

d. Additional skills trained in the institution include techniques for employment, classes of fire, and fire commands. These skills must then be reinforced in the unit. Related soldier skills of camouflage, cover and concealment, maneuver, and preparation and selection of a fighting position are addressed in STP 21-24-SMCT, which must be integrated into tactical training.

e. Training continues in units on the basic skills taught in combat arms IET. Additional skills, such as suppressive fire and supporting fire, are trained and then integrated into collective training exercises, which include squad and platoon live-fire exercises. (A unit M249 marksmanship training program is explained in Appendix A.) The strategy for sustaining the basic marksmanship skills taught in combat arms IET involves periodic preliminary marksmanship training, followed by 10-meter, transition firing, and qualification range firing. However, a unit must establish a year-round program to sustain skills. Key elements include training the trainers and refresher training of nonfiring skills.

f. In the unit, individual proficiency and leader proficiency of marksmanship tasks are integrated into collective training that includes squad, section, and platoon drills and STXs. The collective tasks in these exercises, and how they are planned and conducted, are in ARTEP 7-8-MTP and ARTEP 7-8-DRILL. Collective tasks are evaluated to standard and discussed during leader and trainer after-action reviews. Objective evaluations of both individual and unit proficiency provide readiness indicators and future training requirements.

g. A critical step in the Army's overall marksmanship training strategy is to train the trainers and leaders first. Leader courses include limited M249 AR training, but unit publications will help develop officer and NCO proficiency necessary to plan and conduct marksmanship training and to evaluate the effectiveness of their programs. Proponent schools provide training support materials to include field manuals, training aids, devices, simulators, and programs that are doctrinal foundations and guidance for training the force.

h. Once the soldier understands the weapon, knows how to zero, and has demonstrated proficiency at 10-meter and transition ranges, he should be exposed to more difficult ranges and scenarios.

i. IET culminates in the soldier's proficiency assessment, which is conducted on the 10meter and transition and record fire ranges. Unit training culminates in a collective, live-fire, tactical exercise that provides an overview of unit proficiency and training effectiveness.

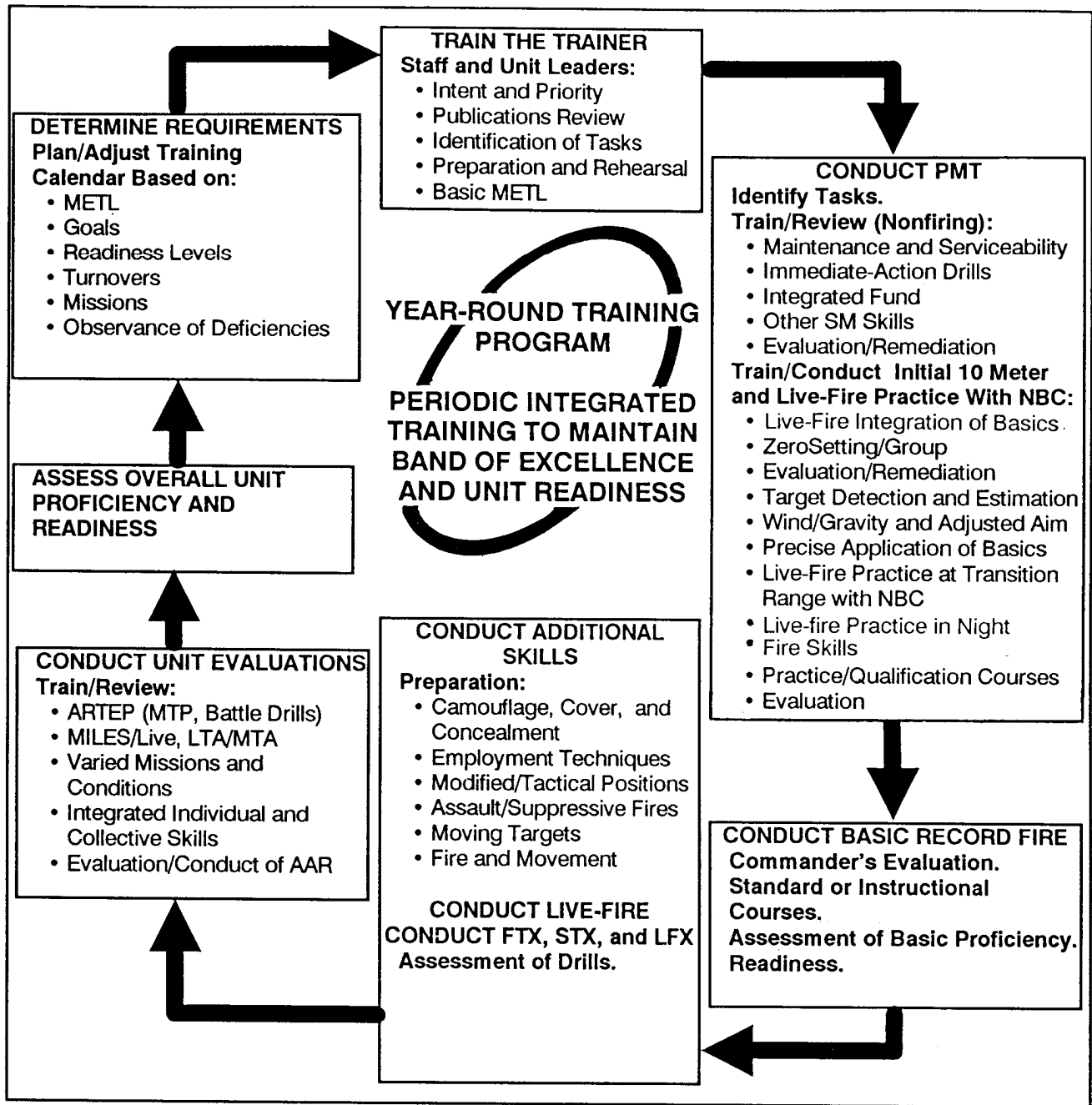

Figure 5-1. Unit marksmanship sustainment strategy.

5-4. TRAINING FOR COMBAT CONDITIONS

The trainer must realize that qualification is not an end but a step toward reaching combat requirements. To reach this goal, the automatic rifleman not only considers his position and the use of his weapon, but also some of the following combat conditions as well.

a. Most engagements will be within 300 meters; however, the automatic rifleman must still engage targets out to the maximum range of the M249 AR.

b. Enemy personnel are seldom visible except when assaulting.

c. Most combat fire must be directed at an area where the enemy has been detected or where he is suspected of being but cannot be seen. Area targets consist of objects or outlines of men irregularly spaced along covered and concealed areas (ground folds, hedges, borders of woods).

d. Most combat targets can be detected by smoke, flash, dust, noise, or movement, but they are visible only for a moment.

e. Some combat targets can be engaged by using reference points, predetermined fire, or range card data.

f. The nature of the target and irregularities of terrain and vegetation may require a firer to use a variety of positions to place effective fire on the target. The most stable position for the automatic rifleman is the prone bipod-supported position.

g. Most combat targets have a low contrast outline and are obscured. Therefore, choosing an aiming point in elevation is difficult.

h. Time-stressed fire in combat can be divided into three types: a single, fleeting target that must be engaged quickly; distributed targets that must be engaged within the time they remain available; and a surprise target that must be engaged at once with instinctive, accurate fire.

Section II. PRELIMINARY MARKSMANSHIP TRAINING

Once a soldier is proficient in the characteristics and mechanical training of the M249, he is ready to be trained on the four fundamentals of marksmanship. As the automatic rifleman learns the fundamentals, he should be required to manipulate the sights, use his body to shift and lay the sights on the target, and respond to fire commands. Dry-fire exercises are an excellent method for training to proficiency.

5-5. FUNDAMENTALS, MARKSMANSHIP

The four fundamentals for firing the M249 are **steady position, aim, breath control, and trigger control**.

a. **Steady Position.** In automatic fire, position is the most important aspect of marksmanship. If the automatic rifleman has a good zero, aims his weapon correctly, and properly applies a steady hold in firing a burst of three rounds, the first round of that burst will hit the target at the point of aim. However, this is not necessarily true of the second and third rounds. The first round hits the aiming point the same as when a round is fired singularly. The recoil from the first and subsequent rounds will progressively disturb the lay of the weapon with each round of the burst. The relationship between the point of impact of the first and subsequent rounds of the burst depends on the stability of the automatic rifleman's position. His body, directly behind the weapon, serves as the foundation, and his grip serves as a lock to hold the weapon against the foundation. The better the body alignment and the steadier the grip, the less dispersed the rounds of a burst of automatic fire will be.

b. **Aim.** To aim the M249 AR, the automatic rifleman must align the sights, focus his eye, obtain a correct sight picture, control his breathing, and maintain trigger control.

(1) *Sight alignment.* Align the rear sight aperture (peep sight) with the sight post of the hooded front sight. Then, align the front sight post in the center of the rear peep sight. An imaginary horizontal line drawn through the center of the peep sight should touch the top of the front sight post, while an imaginary vertical line through the center of the rear peep sight should bisect the front sight post.

(2) *Focus of the eye.* A good firing position places the eye directly on line with the center of the rear sight. Focus on the tip of the front sight post. The natural ability of the eye to center objects in a circle and to seek the point of greatest light (center of peep sight) aids in providing correct sight alignment.

(3) *Sight picture.* A correct sight picture has the target, front sight post, and rear sight aligned. The sight picture consists of sight alignment and placement of the aiming point on the target. Align the tip of the front sight post in the center (Figure 5-2) of the rear peep sight and then align the sights with the target. Align the top of the front sight post on the center base of the target.

c. **Breath Control.** Two types of breath control are used. When firing single shots, as in zeroing, the automatic rifleman stops breathing after most of the air has been exhaled during the normal breathing cycle. He fires before he feels any discomfort. During automatic fire, ideally, the automatic rifleman exhales and stops his breath when pressing the trigger. He does not have time to take deep breaths between bursts. He must hold his breath before each burst or adapt his breathing by taking quick shallow breaths or taking deeper breaths between several bursts.

d. **Trigger Control.** Pressing the trigger straight to the rear and releasing it helps control the number of rounds in each burst and prevents disturbing the lay of the weapon. For a three-round burst, the automatic rifleman presses the trigger to the rear, says "Press, release," and releases the trigger.

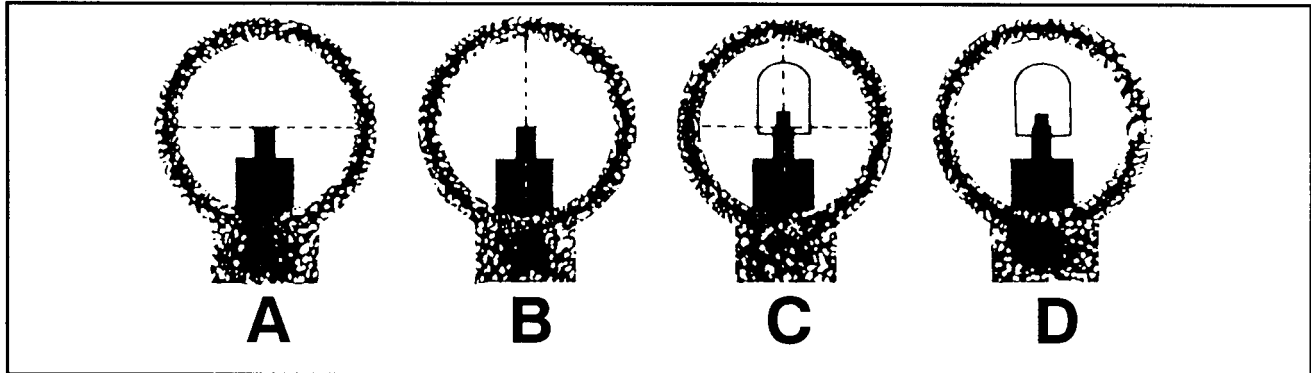

Figure 5-2. Sight picture.

5-6. FUNDAMENTALS, FIRING POSITIONS

The bipod-supported prone position and the bipod-supported fighting position are covered in preliminary marksmanship training.

a. Prone Position, Bipod-Supported.

(1) Assume a prone position to the rear of the weapon and place the shoulder rest on your firing shoulder. An imaginary line drawn through the weapon should bisect the firing shoulder and buttock and continue through the heel of your foot.

(2) Spread your legs a comfortable distance apart with heels as close to the ground as possible and yet still be comfortable.

(3) Grasp the pistol grip with your firing hand with the fleshy end of the index finger resting lightly on the trigger. Place your nonfiring hand on the small of the stock with your thumb curled underneath. Slide your nonfiring hand forward until your little finger touches the receiver, so your aiming point will always be the same.

(4) Place your cheek against the forefinger of your nonfiring hand to form a stock weld. Try to position your nonfiring hand and cheek at the same spot on the stock each time you fire the weapon. The stock weld should provide for a natural line of sight through the center of the rear sight aperture to the front sight post and to the target. Relax your neck so that your cheek rests on your forefinger naturally.

(5) Apply a firm, steady pressure rearward and down, holding the weapon tightly into the hollow of your shoulder while aiming and firing.

(6) Keep your shoulders level and elbows about an equal distance from the receiver of the weapon (Figure 5-3).

NOTE: The M249 AR ejects expended brass and links at a 90-degree angle to the RIGHT and downward from the weapon. Therefore, left-handed firers should roll their sleeves down to avoid the brass.

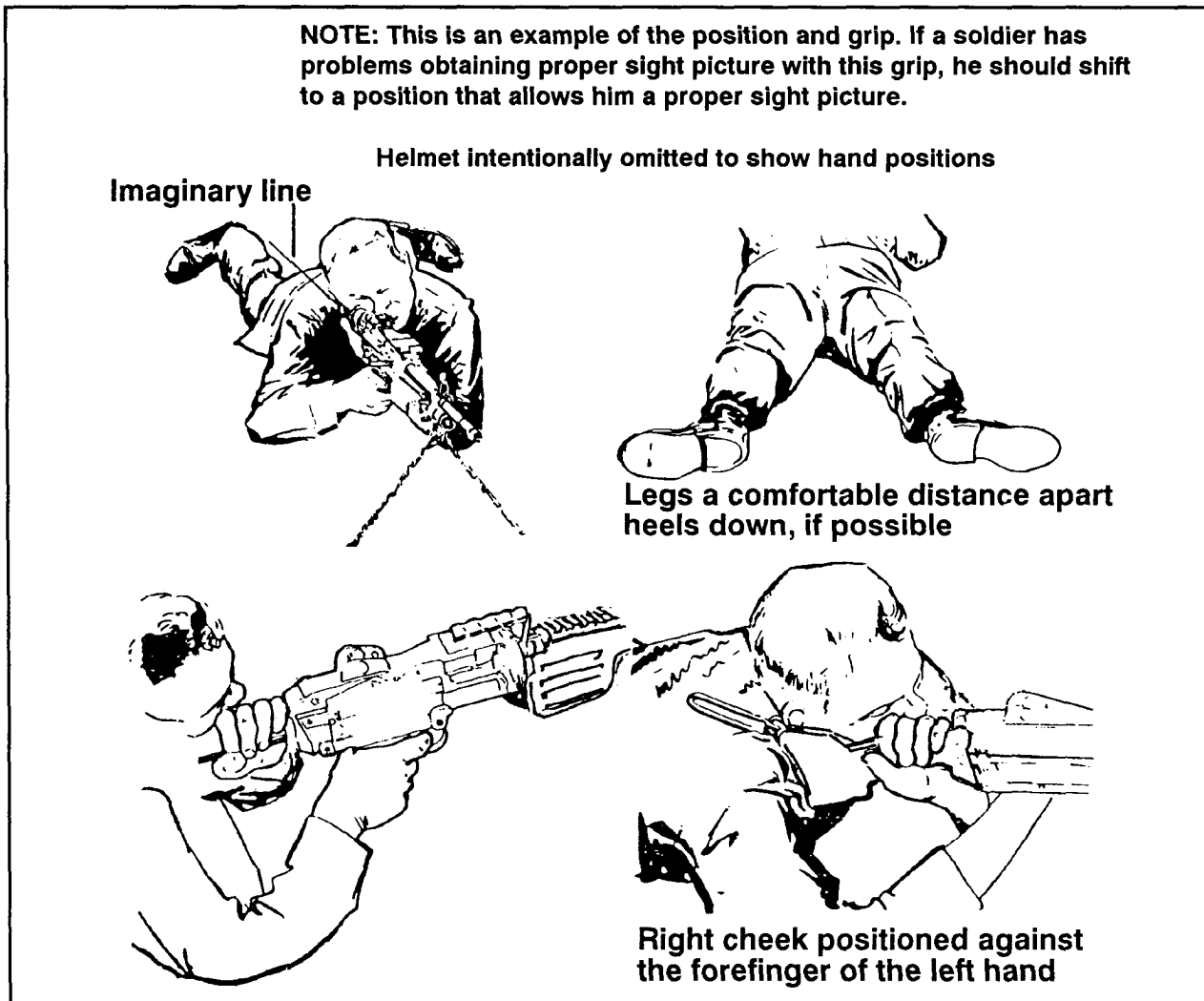

Figure 5-3. Prone position, bipod-supported.

b. Fighting Position (Foxhole), Bipod-Supported.

- (1) Extend the bipod legs and place the M249 AR in front of the position.
- (2) Place your right (firing side foot) foot sideways against the rear of the fighting position and lean forward until your chest is squarely against the forward wall.

(3) Raise the folding shoulder rest and place it on your firing shoulder. Keep your shoulders level or parallel to the ground.

(4) Grasp the pistol grip with your firing hand with the fleshy end of the index finger resting lightly on the trigger. Place your nonfiring hand on the small of the stock with your thumb curled underneath.

(5) Place your cheek against the forefinger of your nonfiring hand to form a stock weld. Try to position your nonfiring hand and cheek at the same spot on the stock each time you fire the weapon. The stock weld should provide for a natural line of sight through the center of the rear sight aperture to the front sight post and to the target. Relax your neck so that your cheek rests on your forefinger naturally.

(6) Apply a firm, steady pressure rearward and down, holding the weapon tight into the hollow of your shoulder while aiming and firing.

(7) Keep your shoulders level and elbows about an equal distance from the receiver of the weapon.

(8) Adjust the bipod legs as needed (Figure 5-4).



Figure 5-4. Fighting position, bipod-supported.

5-7. FUNDAMENTALS, NIGHT FIRING

Although the same four fundamentals of marksmanship are used for night firing, adjustments must be made to accommodate the night vision devices.

a. **Steady Position.** When firing unassisted, changes in head position and stock weld are necessary especially when using weapon-target alignment techniques. Normally, the automatic rifleman positions his head so that he

can align the weapon on the target and look over the sights. In some cases, the lower part of his jaw makes firm contact with his nonfiring hand on the stock, with his eyes an inch or so above the sights. The key is to use the natural pointing ability to align the M249 AR on the target. When using NVDs, the head position and stock weld must be altered to be able to use the device. Sometimes height of the NVD may make this impossible. NVDs alter the M249's weight and center of gravity. The automatic rifleman must compensate by exerting greater pressure and control with his firing hand on the pistol grip and his nonfiring hand on the stock.

b. **Aim.** Various modifications are necessary when aiming the M249 AR at night. When firing unassisted, the automatic rifleman uses off-center vision instead of pinpoint focus. Both eyes are open and focused downrange on the target and not on the sights. Rather than aim using the sights, the automatic rifleman looks over the sights and points the M249 AR where he is looking. The normal tendency is to fire high so the automatic rifleman must improve weapon-target alignment by pointing slightly low to compensate. When using NVDs, the automatic rifleman uses the necessary aiming process to use the device.

c. **Breath Control.** This fundamental is not affected by night firing conditions; however, wobble is more pronounced when using NVDs, because they magnify the field of view.

d. **Trigger Control.** There is no change to this fundamental during night firing. The objective is to not disrupt alignment of the weapon with the target.

5-8. FUNDAMENTALS: NUCLEAR, BIOLOGICAL, AND CHEMICAL

The four fundamentals remain valid in an NBC environment, although some modifications may be needed to accommodate the equipment.

a. **Steady Position.** The bulk of overgarments may require adjustments to the position for stability and comfort. A consistent stock weld is difficult to maintain because of the shape of the protective masks. The automatic rifleman has to hold his head in an awkward position to see through the sight. If necessary, he may cant the weapon to overcome this; this relieves the neck muscles and places the eye on line with the center of the rear sight.

b. **Aim.** The automatic rifleman may have to rotate (cant) the M249 AR to see through the rear sight aperture. He should rotate only enough to align the sights, and only if necessary. Ballistics cause rounds to impact low in the direction of the cant at long ranges. If canting at targets beyond 175 meters, the automatic rifleman must adjust his point of aim. The best technique is to aim at center base of the target initially and then make adjustments based

on the strike of the rounds. Right-handed firers adjust point of aim to the right and high; left-handed firers to the left and high (Figure 5-5).

c. **Breath Control.** Although breathing is somewhat restricted and more difficult while wearing the protective mask, the impact is negligible. Care must be taken, however, to avoid hyperventilating during burst fire. The amount of oxygen inhaled by taking quick shallow breaths or deeper breaths between bursts is significantly reduced.

d. **Trigger Control.** Trigger control is affected when the automatic rifleman wears gloves. The effect cannot be accurately predicted for each soldier; therefore, practice and training under these conditions are required.

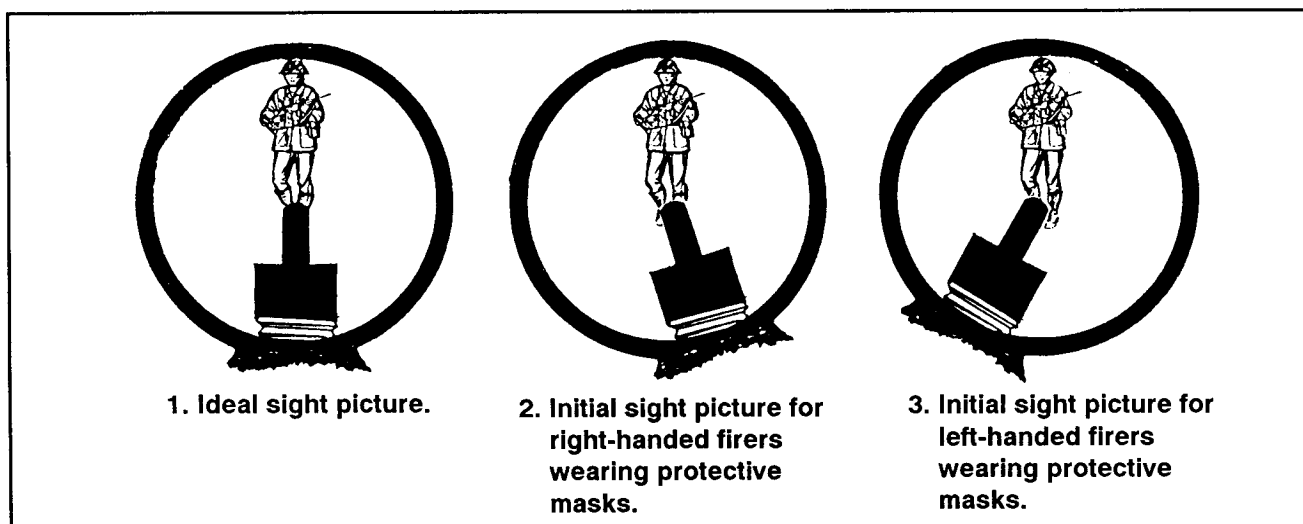

Figure 5-5. Aiming the M249 AR while wearing NBC gear.

5-9. FUNDAMENTALS, MOVING TARGETS

The fundamentals used to hit moving targets are the same as those needed to hit stationary targets. However, the procedures to engage moving targets vary as the angle, speed, and range of the target vary. Targets moving directly at the automatic rifleman are engaged the same as a stationary target; there is no change in the application of the fundamentals. But fast-moving targets at varying ranges and angles do require changes in the application of steady position and aiming. (For aerial targets engagements, see Appendix C.)

a. **Leads.** To hit a moving target, the M249 AR must be aimed ahead of the target a sufficient distance to cause the bullet and target to arrive at the same time at the same point. This distance is measured in target lengths. One target length as seen by the automatic rifleman is one lead. Leads are measured from the center of mass. The simple lead table in Figure 5-6, page 5-12, gives the amount of lead needed to hit a moving target moving at right

angles to the automatic rifleman at speed and ranges indicated. The automatic rifleman makes adjustments as conditions change. If target speed is 7 1/2 mph, the amount of lead is half that shown on the table; at 30 mph, double that shown. The angle the target moves also changes the lead. If the target is moving on an oblique angle, only 1/2 the lead is required. For a target moving directly at the automatic rifleman, the aiming point is below the center base of the target depending on range and slope of the ground. For a target moving directly away from an automatic rifleman, the aiming point is above the center base of the target (Figure 5-7). Too much lead is better than too little because the target moves into the beaten zone, and observation of the strike of the rounds is easier in relation to the target.

SPEED IN MILES PER HOUR	RANGE OF TARGET		
	300 M	500 M	900 M
15	1/2 target length	1 target length	2 target lengths

Figure 5-6. Vehicle lead table.

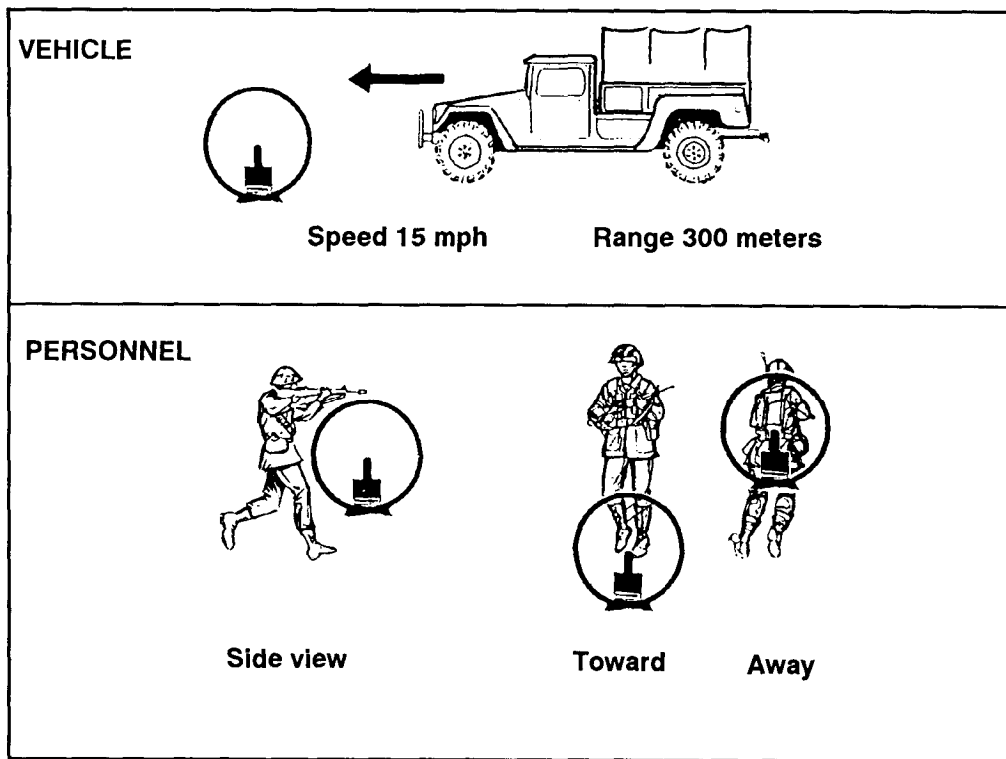

Figure 5-7. Moving target aiming points.

NOTE: A soldier with a combat load can run as fast as 8 miles per hour for short periods on the battlefield.

b. **Tracking Techniques.** The automatic rifleman aims at a point ahead of the target equal to the estimated number of leads, maintains this lead by tracking the target (manipulates the weapon at the same angular speed as that of the target), and then fires. Tracking puts the automatic rifleman in position for a second burst if the first one misses.

c. **Trapping Techniques.** The automatic rifleman establishes an aiming point forward of the target and along the target path. He presses the trigger as the target reaches the appropriate point in regard to lead.

d. **Bipod Techniques.** For targets moving directly away or at the automatic rifleman using a bipod, the same procedures are used. From a prone position, the automatic rifleman may be required to adjust his position quickly depending on range, angle, and speed of the target.

(1) *Steady position.* If appropriate lead cannot be achieved by shifting your shoulders right or left (traverse) or by moving your elbows closer or farther apart (search), redistribute your weight to your elbows and toes and raise your body off the ground. Using your toes, shift your body right or left in the opposite direction of the target and pivot on your elbows until you are well ahead of the target. Rapidly assume a steady position, obtain the sight picture, lead and engage the target. Trapping is the preferred technique. In order to apply this method, the bipod legs must move freely. When firing from a fighting position, you must be flexible enough to track any target in your sector. If lead cannot be achieved, slide the bipod legs in the appropriate direction (left or right) ahead of the target and continue as in the prone position. Trapping is still the preferred technique. If the terrain does not permit sliding the weapon left or right, lift the bipod legs off the ground and place them where you can aim ahead of the target, reestablish a steady position, and continue as before.

(2) *Aim.* You must determine angle, speed, and range quickly; acquire the appropriate lead; and engage the target. Align the front sight post in the proper relationship to lead the target. For targets moving directly away, place the front sight post above center of mass. For targets moving directly at you, align the front sight post below center of mass. For all other targets, align the front sight post with center base of the target with the appropriate lead.

(3) *Breath control.* There are no changes except that you must hold your breath quickly because of the fleeting nature of moving targets.

(4) *Trigger control.* There is no change in the application of this fundamental.

5-10. FUNDAMENTALS, TRAVERSE AND SEARCH

Traverse moves the muzzle of the weapon to the left or right to distribute fire laterally. Search moves it up or down to distribute fire in depth.

a. **Traverse.** To make minor changes in direction, the automatic rifleman shifts his shoulders to the right or left to select successive aiming points in the target area. Major changes require him to redistribute his weight to his elbows and toes and raise his body off the ground. Using his toes, he shifts his body to the right or left to be in the opposite direction of the target, and pivots on his elbows until he is once again aligned with the target. He rapidly assumes a steady position, obtains the proper sight picture, and engages the target.

b. **Search.** Searching is moving the muzzle of the weapon up or down to distribute fire in depth. To make changes in elevation, the automatic rifleman moves his elbows closer together to lower the muzzle or farther apart to raise the muzzle. Gross errors in range are corrected by adjusting the range setting with the elevation knob.

5-11. DIRECT LAY

The simplest, quickest, and most effective technique of delivering fire with the M249 with bipod is to align the sights on the target and properly apply fire. This technique of fire is called **direct lay**.

5-12. APPLICATION OF FIRE

The automatic rifleman must aim, fire, and adjust on a certain point of the target. He always keeps the center of his beaten zone at the center base of the target for maximum effect from each burst of fire. When this is done, bullets in the upper half of the cone of fire will run through the target if it has height, and the bullets in the lower half of the beaten zone will ricochet into the target.

5-13. ADJUSTMENT OF FIRE

The automatic rifleman initially sets his sights with the range to the target, lays on the target (sight alignment and sight picture on the center base of the target), fires a burst, and observes the strike of the rounds or flight of the tracers. When the initial burst is correct, he continues to fire until the target is covered. He must regain a good sight picture before each burst when firing with the bipod.

a. **Sight Corrections Method.** An automatic rifleman must observe and adjust fire rapidly to be effective. He observes bursts of fire by noting the strike of the rounds in the target area and the tracers in flight. The technique

to adjust fire depends on time, range, and amount of adjustment. These factors assist the automatic rifleman in determining whether or not to make sight corrections or adjust position and point of aim. When the initial burst is not correctly placed, the automatic rifleman may change the elevation and windage on the sights and fire another burst on the target. This method is time-consuming, even for the well-trained soldier.

b. **Adjusted Aiming Point Method.** In this method of fire adjustment, the automatic rifleman uses his sight but does not make sight corrections. This is the quickest method. If the automatic rifleman misses the target with his initial burst, he must rapidly select a new aiming point the same distance from the target as the center of impact of the initial burst, but in the opposite direction. For example, if the strike of the rounds of the initial burst is 20 meters beyond and 10 meters to the right of the target, he rapidly selects an aiming point about 20 meters short and 10 meters to the left of the target, lays on that aiming point, and fires (Figure 5-8). When selecting a new aiming point, he may have to shift his shoulders slightly to the left or right for windage corrections. For elevation changes, he moves his elbows closer together (lowers the impact) or farther apart (raises the impact). For large corrections, he must move his elbows and realign his body to remain directly behind the weapon. He does this by redistributing weight to his elbows and toes and raises his body off the ground. He shifts his body using his toes, to the right or left, pivoting on his elbows until he is on line with the target. Then he assumes a steady position, obtains the sight picture, and engages the target.

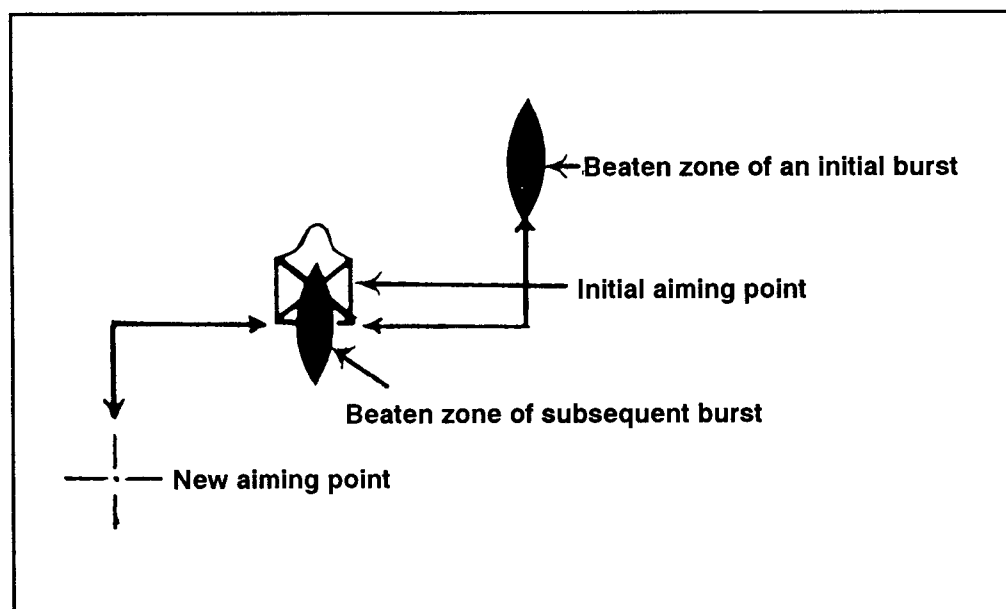

Figure 5-8. Adjusting aiming point method.

5-14. EFFECTS OF WIND

The effects of wind vary depending on changes in speed and direction. Wind is classified by the direction it is blowing in relationship to the firer and target line. The **clock system** is used to indicate wind direction and value (Figure 5-9).

a. **Clock System.** Winds that blow from the left (9 o'clock) or right (3 o'clock) are called **full-value winds**, because they have the most effect on the bullet. Winds that blow at an angle from the front or rear area are called **half-value winds**, because they have about one-half the effect on the bullet as full-value winds. Winds that blow straight into the firer's face or winds that blow straight into the target are termed **no-value winds**, because their effect on the bullet is too small to be a concern. Effects of the wind increase as the range increases. Figure 5-10 shows the effects of a 10-mph wind at varying ranges. A 20-mph wind doubles the effect. Winds at other than right angles have less effect. As indicated in Figure 5-10, wind has almost no effect up to 300 meters.

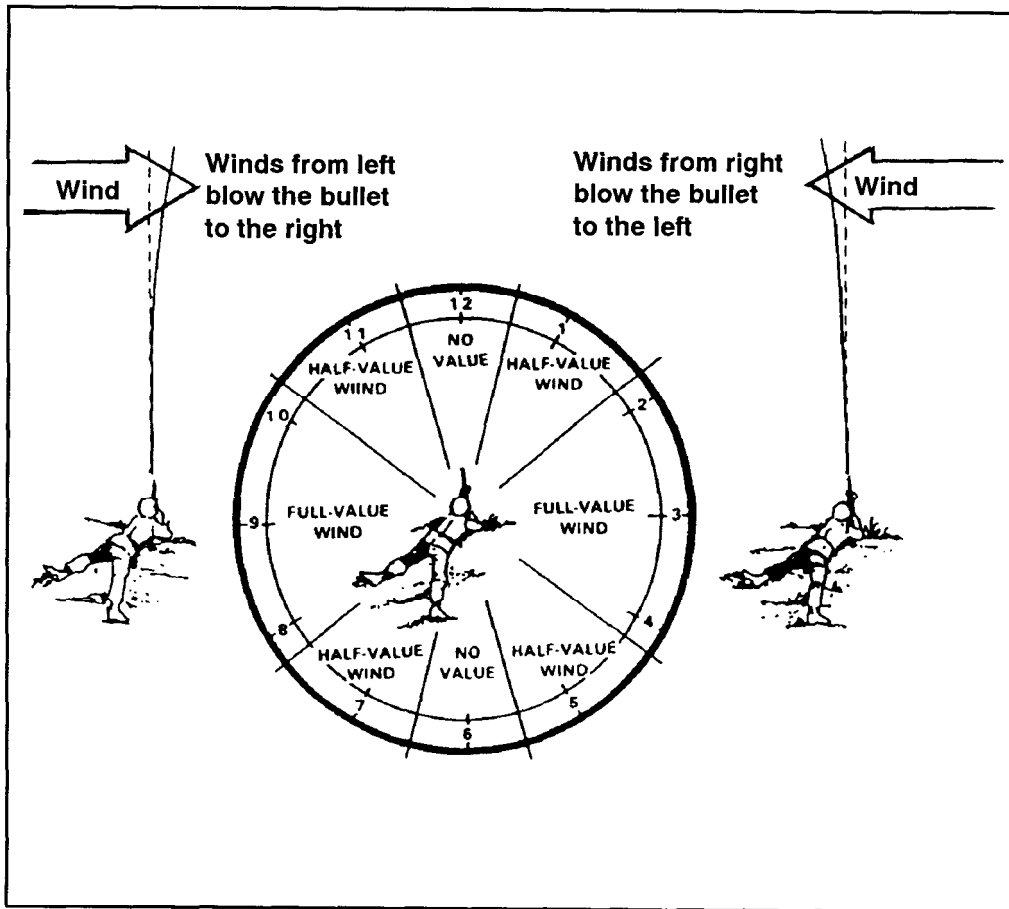

Figure 5-9. Clock method.

Range Meters	10-mph Wind Drift	
	(Inches)	(CM)
100	1	(2.54)
200	5	(12.70)
300	12	(30.48)
400	23	(53.42)
500	39	(49.06)
600	60	(152.04)
700	88	(223.52)
800	121	(307.34)
900	159	(403.86)
1,000	202	(513.08)

Figure 5-10. Effects of winds.

NOTE: When in doubt, the automatic rifleman aims the initial burst directly at the center base of the target and, using the techniques of observation and adjustment of fire, adjusts the fire onto the target.

b. Wind Measurement. Wind is highly variable and sometimes quite different at the firing position than at the target position. Even though the wind is blowing hard at the firing position, the bullet path could be protected by trees, brush, or terrain. The wind can vary by several miles per hour between the time a measurement is taken and when the bullet is fired. Therefore, training time should not be wasted trying to teach automatic riflemen an exact way to measure wind speed. They should know that even though wind can affect trajectory, it can be overcome by adjusting fire. A wind gauge can be used for precise measurement of wind velocity. When a gauge is not available, velocity is estimated by one of the following methods.

(1) *Observation method.* The following information can assist in determining wind velocities.

(a) Winds under 3 mph can barely be felt, but the presence of slight wind can be determined by drifting smoke.

(b) Winds of 5 to 8 mph constantly move the leaves of trees.

(c) Winds of 8 to 12 mph raise dust and loose paper.

(d) Winds of 12 to 15 mph cause small trees to sway.

(2) *Pointing method.* A piece of paper or other light material can be dropped from shoulder height. By pointing directly at the spot where it lands, the angle can be estimated. As shown in Figure 5-11, page 5-18, this angle is

also divided by the constant number 4 to determine the approximate wind speed in miles per hour. However, this only indicates conditions at the firing position; they may be different at the target.

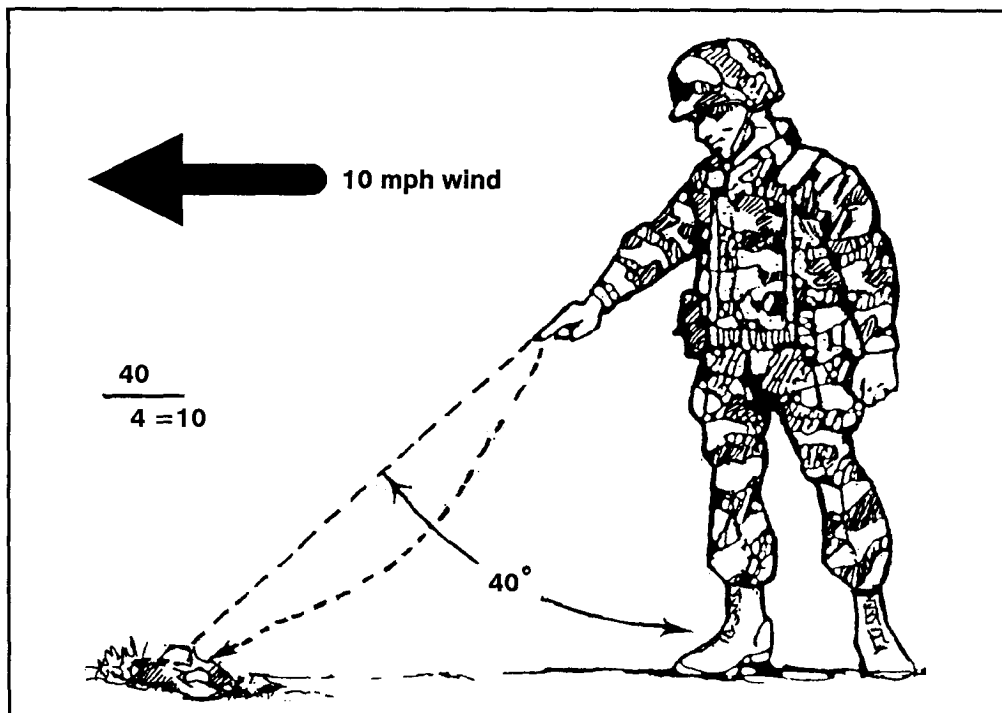

Figure 5-11. Pointing method.

5-15. FIRE COMMANDS

The standard fire command is used as a means of control during preliminary, basic, and advanced marksmanship training. The fire command must be explained to the automatic rifleman. The elements are given (as appropriate) before each dry-fire or live-fire exercise. The automatic rifleman takes action as directed and repeats each element as it is announced. (For a detailed explanation of fire commands, see Chapter 6.) When using the basic 10-meter range target, the fire command elements are—

- a. **Alert.** The alert is given as "Automatic rifleman." Upon hearing the alert, the automatic rifleman loads his weapon and places the safety on FIRE.
- b. **Direction.** Direction is given as FRONT since the targets appear to the automatic rifleman's front on the basic range.
- c. **Description.** Description is given as PASTER NUMBER (pasters 1 through 8 as appropriate), at which time the automatic rifleman lays his weapon on the announced paster.

d. **Range.** An elevation of 700 meters on the rear sight assembly is always used on the basic range. This is announced as SEVEN HUNDRED, at which time the automatic rifleman must ensure that his rear sight assembly has the correct elevation setting.

e. **Method of Fire.** Firing on the basic range is at a point target, so the method of fire is announced as FIXED. The automatic rifleman fires either single rounds or bursts at a rate slower than the sustained rate; therefore, the rate-of-fire element is omitted.

f. **Command to Open Fire.** This is announced as AT MY COMMAND. When the automatic rifleman is ready, he announces "Up." When all automatic riflemen are ready to fire, the command FIRE is given.

5-16. DRY-FIRE EXERCISES

Dry-fire exercises train the techniques of loading, unloading, immediate action, fundamentals of marksmanship, and sight manipulation. These exercises may be conducted using blank or dummy ammunition and should be conducted using fire commands when appropriate. If the blank firing attachment is used, safety restrictions for its use must be enforced. While the automatic rifleman performs the tasks, the coach—

- Checks the sight setting and initial lay.
- Checks the automatic rifleman's position.
- Ensures the automatic rifleman simulates firing before adjusting his position.
- Checks for proper body adjustment.
- Critiques the automatic rifleman at the end of the exercise.

a. **Loading and Unloading Exercises.** The procedures for loading and unloading are prescribed in Chapter 3 and should be reinforced using dummy ammunition. This training instills confidence and proficiency in the operation of the weapon. It also provides training in clearing the weapon.

b. **Immediate-Action Exercise.** This exercise is conducted using linked dummy rounds and the basic machine gun target (see paragraph 5-18, page 5-23). The instructor should use salvage links to link the dummy rounds together.

(1) Load the weapon with dummy ammunition and aim at one of the aiming pasters on the basic machine gun target.

(2) Being conscious of the sight picture, press the trigger and the bolt goes forward (simulate firing the weapon). If you disturbed the sight picture, check your position and grip, and maintain better control of the weapon.

(3) If you have a stoppage, apply immediate-action procedures and continue to fire.

c. **Operational Exercise.** The automatic rifleman aims and simulates firing each dummy round at the aiming paster on the basic machine gun target.

(1) Observe the sight picture through the feeding, locking, and firing cycle. This provides feedback on your ability to maintain and hold the sight picture.

(2) If at the completion of the firing cycle you observe significant movement of the sight picture, your position is not steady enough.

(3) Apply immediate action after firing each shot to extract and eject the dummy cartridge and return the bolt to the cocked position. Return the cocking handle to the forward position.

d. **Sight Setting and Sight Change Exercises.** These exercises are to train the automatic rifleman in the operation and adjustment of the rear sight.

(1) For large adjustments in elevation (range), manipulate the rear sight to different range settings (300 to 1,000 meters). For fine adjustments in elevation, manipulate the rear peep sight through its maximum range from bottom (0 clicks in elevation) to the top (9 clicks in elevation).

(2) To make adjustments for windage, traverse the rear sight across the sliding scale.

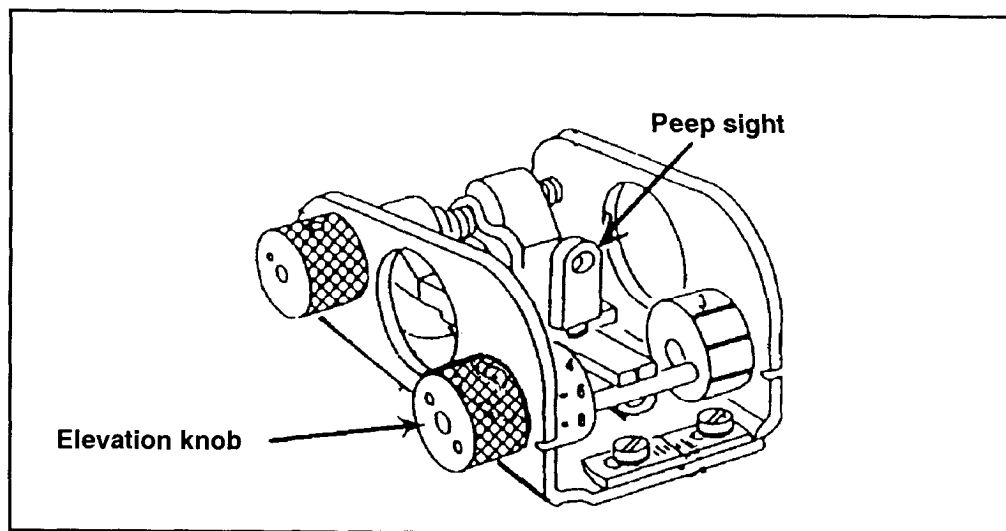

Figure 5-12. Sight adjustments.

NOTE: Before they are given the dry-fire proficiency examination, soldiers should practice the tasks until they become proficient.

e. **Traversing and Searching Exercise.** After the automatic rifleman knows the principles of sighting and aiming and can assume a satisfactory

firing position, he learns how to make minor and major body changes to obtain an accurate initial lay by using body position changes. He practices shifting the direction of the weapon to successive points by manipulating his body. The basic machine gun target is placed 10 meters from the weapon for this exercise.

(1) Make adjustments for large shifts in direction by using the elbows-and-toes technique described earlier. Make small changes in direction by adjusting your shoulders.

(2) Make major elevation changes by adjusting the elevation knob. Make minor elevation changes by adjusting your elbows.

(3) Traverse and search the target by sighting on the initial aiming paster (number 5 or 6) and then shifting to each of the other pasters in order (5 through 6 or its reverse).

(4) Upon receiving a fire command, repeat the instructions, set the sights, lay the weapon on the designated paster, assume the correct position, and report UP.

(5) At the command FIRE, simulate firing two single shots, then shift to the next paster and simulate firing until the exercise is complete.

f. Dry-Fire Proficiency (Performance) Examination. An automatic rifleman must demonstrate skill in all the tasks of the dry-fire proficiency examination before he is allowed to progress to 10-meter live firing. This examination emphasizes learning by doing. Proficiency is tested on a pass or fail basis. (The proficiency testis in Appendix B.)

g. Remedial Training. Remedial training must be given to soldiers who fail the performance objectives. Automatic riflemen who have passed the proficiency test may be used to assist in the training of soldiers having difficulty. Following retraining, the soldiers are retested in those tasks.

5-17. MULTIPURPOSE MACHINE GUN RANGE LAYOUT

The multipurpose machine gun range is used for conducting the 10-meter course as well as transition day, night, and integrated NBC firing. The firing area has 10 lanes. (Detailed setup and target configuration are described in TC 25-8. The layout is shown in Figure 5-13, page 5-22.) Personnel required for conducting the 10-meter range as well as the transition firing are the same, and they should perform the same duties for each training period. Local policy may dictate personnel requirements. The following are the minimum required personnel: OIC, NCOIC, safety officer or NCO, ammunition NCO, tower operator, lane NCOs, trainer and coaches, or IAW TC 25-8. All personnel must adhere to safety rules in accordance with AR 385-63, local regulations, and Appendix D.

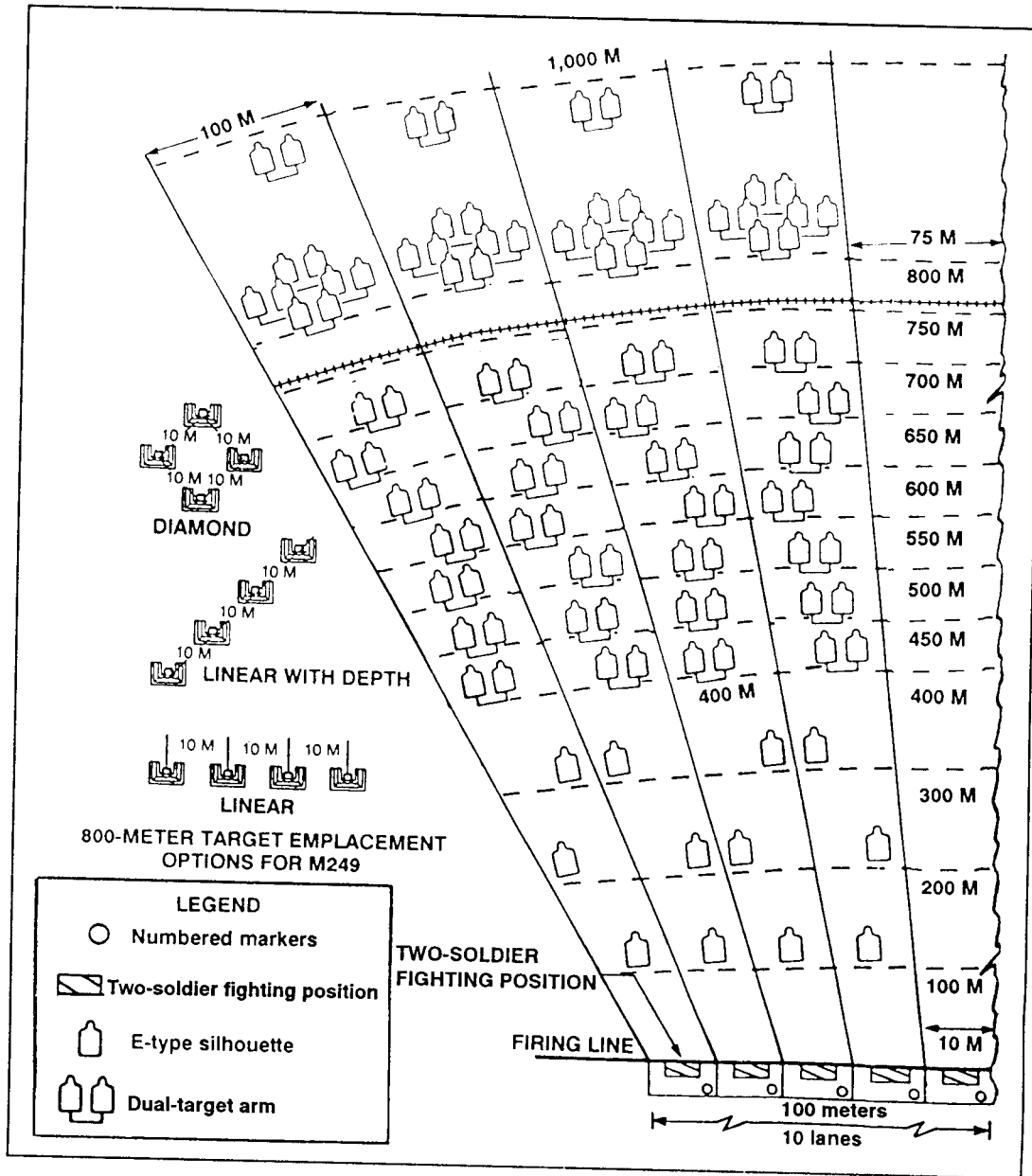

Figure 5-13. Range layout.

5-18. BASIC MACHINE GUN TARGET

The basic machine gun target (FSN 6920-078-5128) is used for the 10-meter firing exercise (Figure 5-14). The following explanation of the target, including the size of the aiming pasters and scoring spaces, aids in zeroing the M249s and facilitates control during the 10-meter firing exercises. The target consists of four sections lettered A, B, C, and D. Each section has four point targets numbered 1, 2, 3, and 4; and two sets of area targets numbered 5 through 6 and 7 through 8. Each space is 4 cm wide and 5 cm high. The black aiming paster within the numbered scoring spaces is 1 cm square. The target is used to score two automatic riflemen—one uses sections A and B, and the other automatic rifleman uses sections C and D.

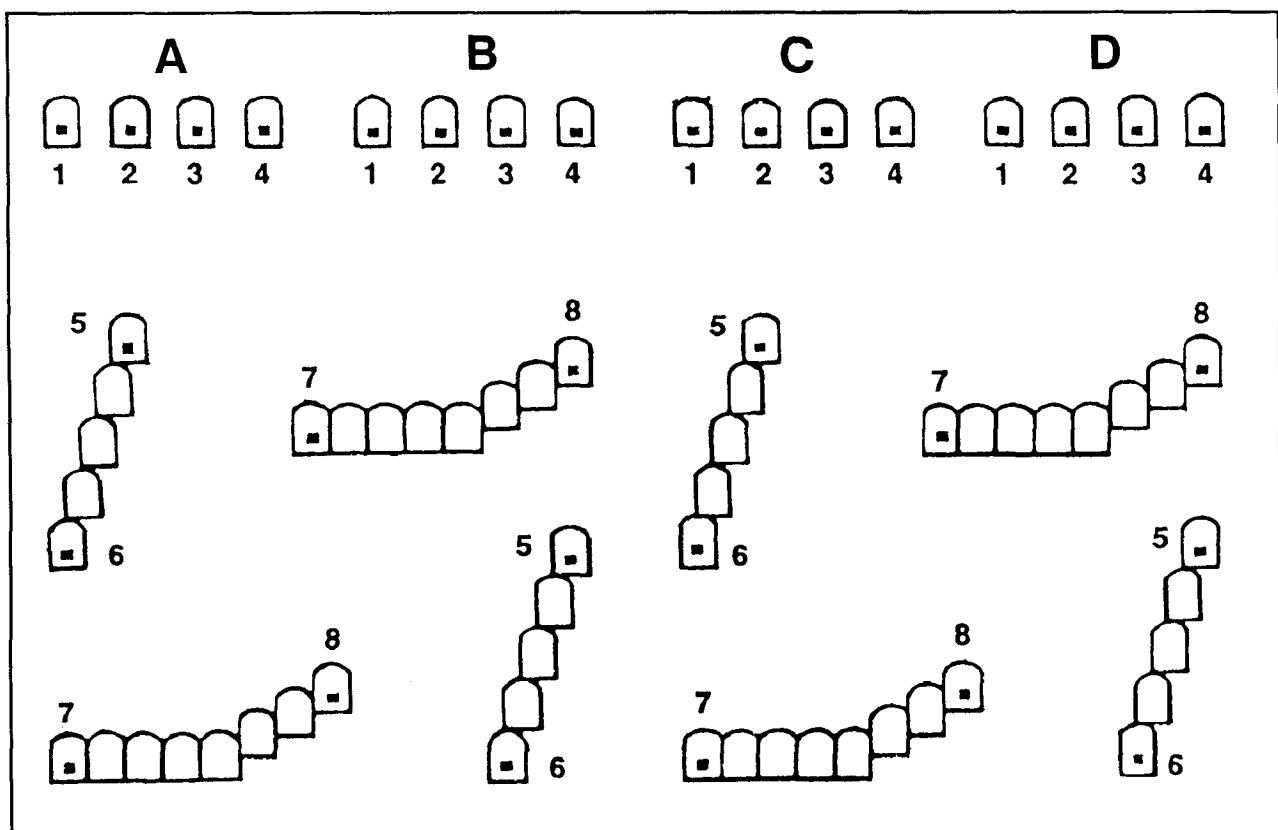

Figure 5-14. Basic machine gun target.

a. **Point Targets.** Point targets on the basic machine gun target are pasters 1 through 4 of sections A, B, C, and D. Firing at point targets exposes the automatic rifleman to zeroing techniques and controlled-burst fire techniques. Targets 1 through 4 can also be used for qualification.

b. **Area Targets.** Area targets on the basic machine gun target consist of pasters 5 through 6, and 7 through 8 of sections A, B, C, and D. Target group 5 through 6 provides the automatic rifleman with targets in depth and allows him to use a series of aiming points to disburse fire across the target by using body position changes. Target group 7 through 8 provides the automatic rifleman with linear targets with depth. This series of targets uses a series of aiming points to disburse fire across the target and in depth by using body position changes.

c. **Grid Square Overlay.** This device assists the automatic rifleman in zeroing his weapon at 10 meters, while using the basic machine gun target (Figure 5-15). The grid square overlay is used the same as an M16 25-meter zero target, except the material can be made of plastic or view graph transparency. Each square is equal to 1 cm.

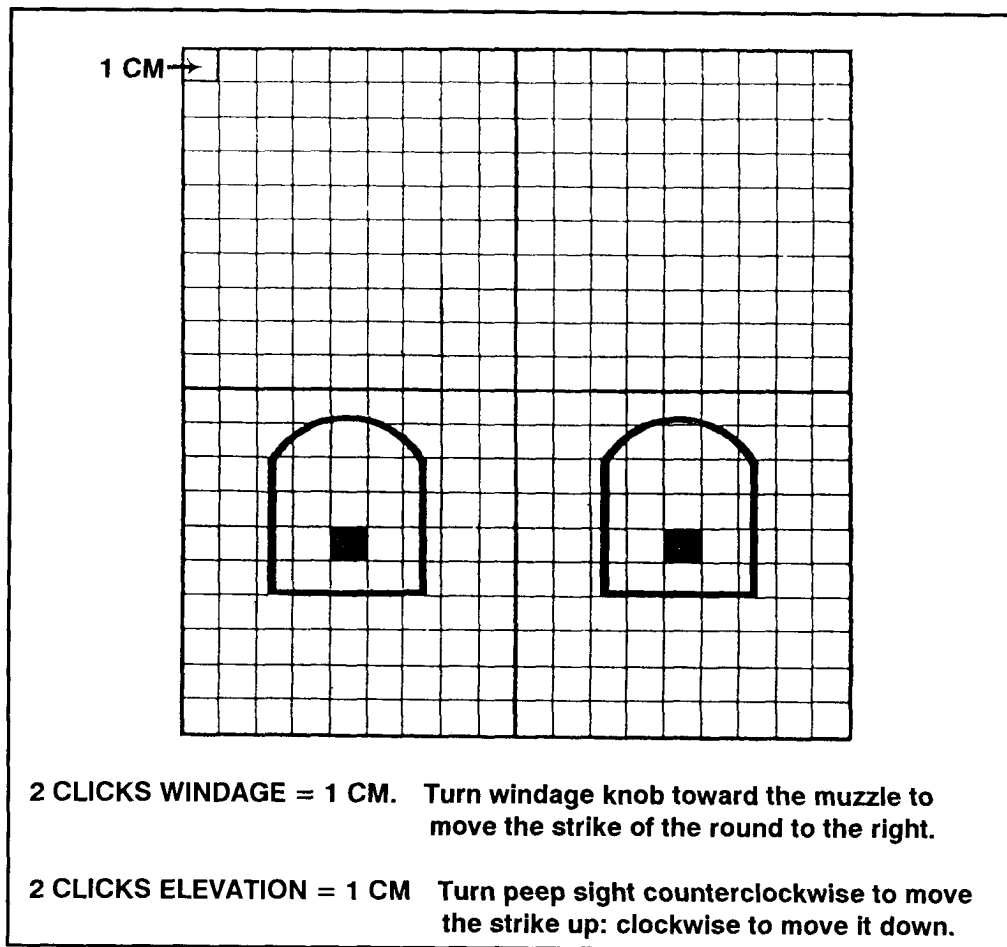

Figure 5-15. Grid square overlay.

(1) Set the sights for 10-meter zeroing, then fire a three-round shot group.

(2) After firing the second three-round shot group (Figure 5-16), place the grid square overlay over the pasters (1 and 2) (Figure 5-17) and count the number of clicks it will take for rounds to impact on the black aiming paster. (Corrections for Figure 5-17 would be turn the windage knob toward the muzzle (clockwise) two clicks.)

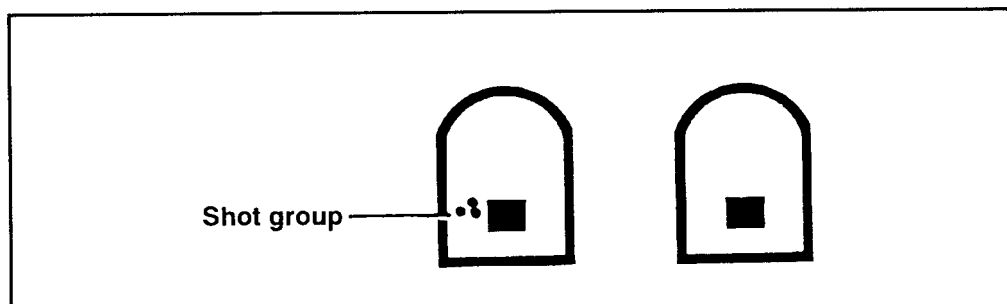

Figure 5-16. Shot group on basic machine gun target.

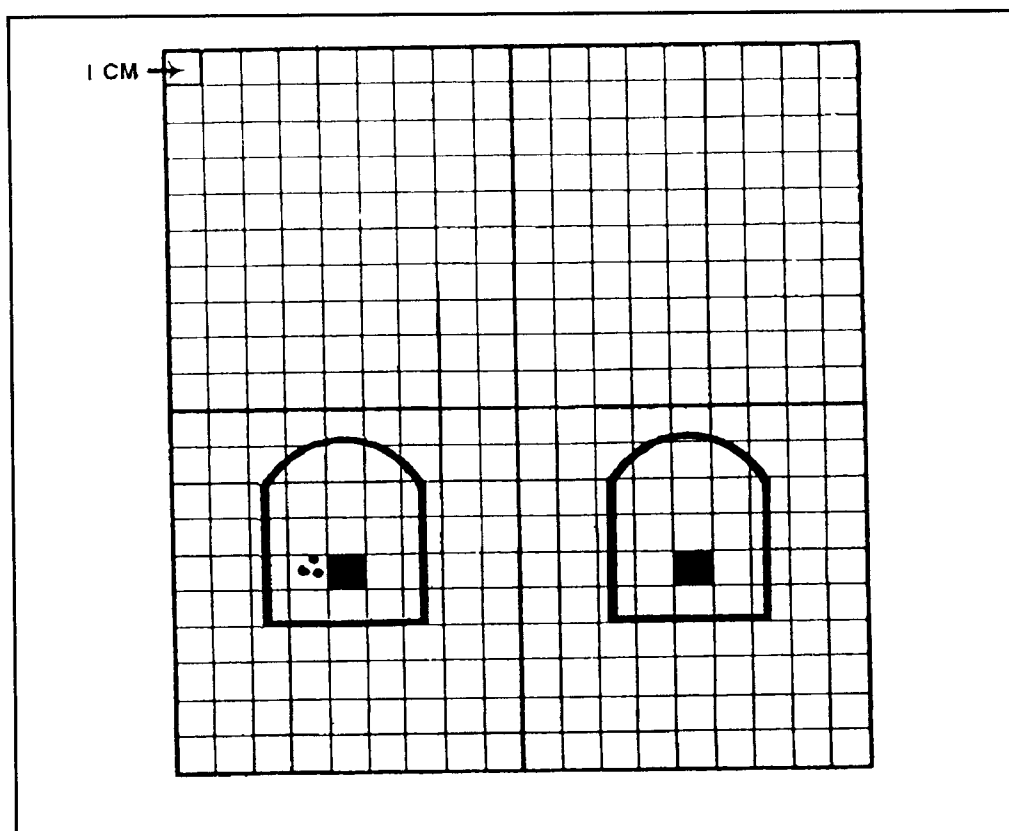

Figure 5-17. Overlay placed over pasters.

5-19. TARGET ANALYSIS

Targets are analyzed and scored to determine the automatic rifleman's proficiency and to reinforce the fundamentals of marksmanship. During prone or fighting position firing with a zeroed weapon, a target is best analyzed by considering the common errors of M249 marksmanship (Figure 5-18).

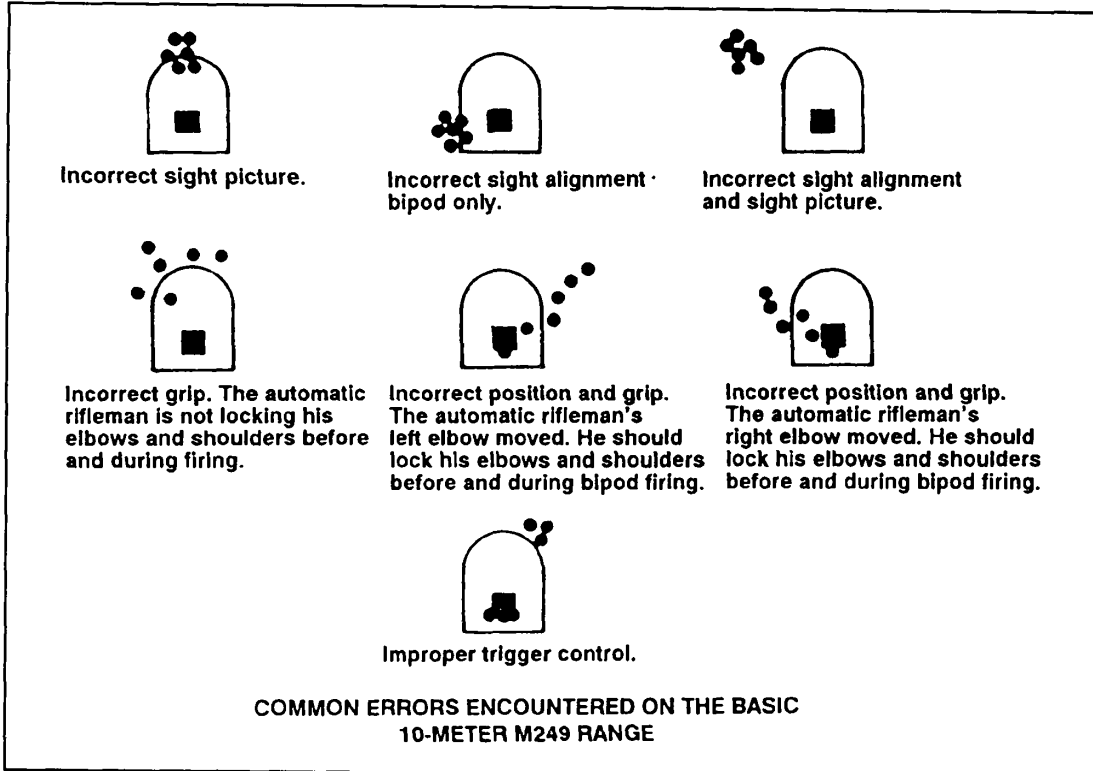

Figure 5-18. Common errors of marksmanship.

5-20. 10-METER SCORING PROCEDURES

When scoring the 10-meter target, the trainer scores all scoring spaces (1 through 4, 5 through 6, and 7 through 8). One point is given for each round impacting within each scoring space. The maximum point value is 3 points for each scoring space. Rounds touching the line on the paster are considered a HIT. When firing at 1 through 4 with a belt of 12 rounds, the maximum score the automatic rifleman can receive is 12 points. When firing at pasters 5 through 6, he engages the five scoring spaces with a 15-round belt. The maximum score possible is 15 points. When firing at pasters 7 through 8, the

automatic rifleman engages the eight scoring spaces with 24 rounds with a maximum score of 24 points. Automatic riflemen score their own targets during practice, but not during record fire. DA Form 7304-R (Scorecard for M249 AR) is used to record scores (see paragraph 5-30, page 5-50.)

NOTE: A blank reproducible copy of this form is in the back of this manual.

a. The total possible score is 51 points. A minimum of 35 points is required to qualify on the 10-meter course of fire.

b. Soldiers failing to achieve minimum standards must be retrained and retested in a dry-fire mode until proficiency is demonstrated. They do not go on to transition firing. Soldiers should refire the 10-meter portion with close supervision and coaching to ensure that the fundamentals of marksmanship are applied during live fire.

Section III. BASIC MARKSMANSHIP, LIVE-FIRE EXERCISES

In basic marksmanship, the automatic rifleman applies the fundamentals in live-fire exercises during day, night, and NBC conditions. This includes lo-meter zeroing, 10-meter firing, field zeroing, transition firing, and record firing.

5-21. ZEROING

Zeroing aligns the sights with the barrel so that the point of aim equals the point of impact. Ten-meter zeroing is for conducting 10-meter fire only and has no further application. (Zeroing at range or field zeroing is the automatic rifleman's battlesight zero and must be recorded.)

a. **10-Meter Zeroing, Set the Sights (Mechanical Zero).** The automatic rifleman indexes or places the elevation knob on a range of 700 meters. He centers the rear peep sight by rotating it clockwise (right) as far as it will go, then rotating counterclockwise (left) 5 clicks or half-turns. He rotates the windage knob toward the muzzle until the peep sight is **completely** to the right, then rotates the windage knob toward the buttstock 12 clicks to the left. This places the peep sight in the approximate center of the sight. Each sight may vary as to how many clicks are needed. To check the sight, the automatic rifleman starts with the sight all the way to the right and, while counting the clicks, rotates the windage knob until it stops on the left side. He divides the clicks by two. If it is an uneven number, he rounds it up. To center the sight, he rotates the windage knob toward the center (right) while counting the appropriate number of clicks. He adjusts the sliding scale at the rear of the sight to center the large index line under the zeroed windage mark

on the sight. Two threads should be showing on the front sight post. If more or less are showing, the automatic rifleman turns in the weapon for maintenance.

b. **Three-Round Group.** The automatic rifleman fires three single rounds loaded individually at the center base of the aiming points on the basic machine gun marksmanship target. He fires the three rounds without making any adjustments to the sights. The shot group must be about a 4-cm circle or smaller to establish the center of the group in relation to the center base of the aiming paster. Establishing a smaller shot group is difficult, because the M249 AR is an open-bolt weapon. Sight alignment is disturbed somewhat as the bolt moves forward during firing.

c. **Grid Square Overlay.** For a more accurate adjustment, the automatic rifleman moves downrange and places the grid square overlay over pasters 1 and 2. He ensures that he aligns the overlay with the pasters and squares.

(1) Count the number of squares it will take to move the shot group to the aiming paster.

(2) Upon completion, return to the firing line to make corrections to the weapon. Figure 5-19 illustrates a zero group size on which adjustments can be made and a group that is too loose for adjustments. If a group is too loose, check your position and grip.

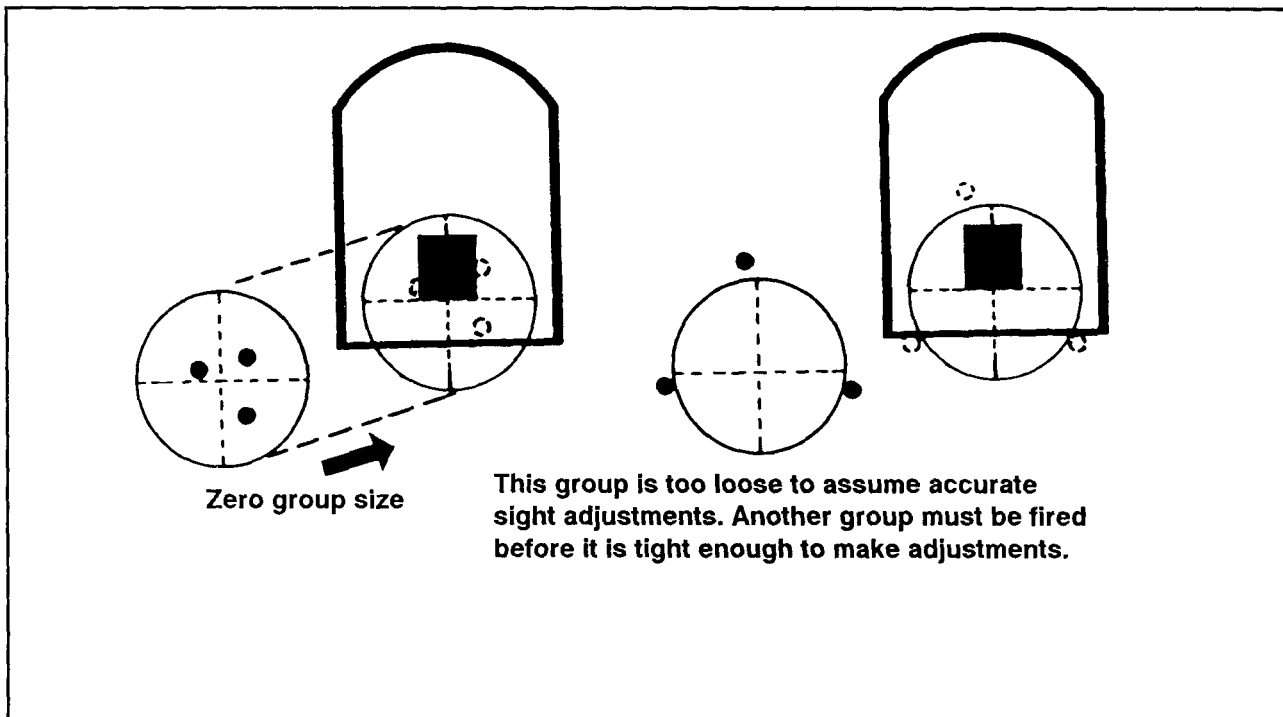

Figure 5-19. Zero group size.

d. **Windage Correction.** If the center of the group is to the left or right of the black aiming paster, the automatic rifleman must correct for windage. To do this, he must rotate the windage knob to move the peep sight in the direction of the desired change (rotate windage knob toward the muzzle [counterclockwise] to move the strike of the round to the right; rotate the windage knob toward the buttstock [clockwise] to move the strike of the round to the left). One click in either direction moves the strike of the round 1/2 cm at 10 meters.

EXAMPLE: If the automatic rifleman sees that the center of the shot group is 2 cm (two black aiming pasters) to the left of the aiming point, he adjusts the point of impact four clicks in the direction of the aiming point (to the right) by rotating the windage knob toward the muzzle.

e. **Elevation Correction.** Before making elevation adjustments, the range knob must be at its highest setting. If the center of the shot group is above or below the aiming point, the automatic rifleman rotates the peep sight clockwise to lower the strike of the round or rotates the peep sight counterclockwise to raise the strike of the round. One 180-degree turn in either direction moves the strike of the round 1/2 cm at 10 meters.

f. **Confirmation.** The automatic rifleman fires another three-shot group (loaded singly) after making his corrections for windage and elevation. If the center of the group is still off the aiming point, he adjusts further until the group is centered on the point of aim.

g. **Recording.** There is no reason to record the 10-meter zero, because it applies only to firing at the 10-meter basic machine gun target.

5-22. FIELD ZEROING

Automatic riflemen must know how to zero the M249 AR at distance. He should select a known distance target between 300 and 700 meters. It is difficult to determine fully where the center of the beaten zone is in relation to the target as range increases. Therefore, the 300-meter target on the transition range is recommended because of the ease of determining adjustments.

a. **Set the Sights.** The automatic rifleman uses the same procedures as for 10-meter zeroing are used except that he places the elevation knob on the range to the target. The recommended range is 300 meters.

b. **Fire a Three-Round Burst.** The automatic rifleman assumes a good stable position and fires a three-round burst at the center base of the target and notes where the burst strikes.

c. **Correct for Windage.** If the center of the beaten zone is to the left or right of the target, he corrects for windage. Each click moves the strike

of the rounds 1/2 mil or 6 inches at 300 meters. He adjusts the windage knob accordingly.

d. **Correct for Elevation.** If the center of the beaten zone is high or low in relation to the target, he corrects for elevation. Because determining that relationship is difficult, automatic riflemen rely on trial and error to gain sufficient experience in making reliable estimates. He makes corrections in the same manner as 10-meter zeroing.

e. **Confirm.** After making corrections for windage and elevation, he fires a confirming burst of three rounds. If the target is not hit, he repeats the procedures.

f. **Record Zero.** Upon confirming the zero, he records it by counting the number of clicks (half-turns) he moved the peep sight for elevation in relation to the initial setting of 5. For example, if he made two half-turns up, he records UP 2. If he made two half-turns down, he records DOWN 2. Adjustments for the windage scale are not recorded; instead, he loosens the windage sliding scale screws and aligns the scale so that the large index line is under the windage mark on the sight. Then, he tightens the screws.

5-23. 10-METER FIRING

The 10-meter firing trains automatic riflemen to apply the fundamentals of automatic rifle marksmanship in live-fire exercises. It familiarizes the soldier with the weapon's characteristics, noise, and recoil. It instills in the soldier confidence in his weapon. Each automatic rifleman learns to zero his M249 AR, conducts controlled-burst fire at point targets, and uses traverse and search techniques of fire at area targets. The 10-meter firing is conducted on a 10-meter range or a multipurpose range using the basic machine gun target. These exercises are fired with the bipod from both the prone position and the fighting position. The 10-meter firing exercises are for practice as well as part of record qualification. All 10-meter firing exercises are recorded and scored to provide the automatic rifleman an assessment on his performance. The 10-meter firing is conducted IAW Firing Table I (Table 5-1, page 5-36). There are seven tasks.

a. **Task 1, Zero.** The automatic rifleman fires single shots to determine his weapon's zero for 10 meters. This task reinforces the dry-fire experience and allows the automatic rifleman practice loading, while providing the most accurate and tight shot group obtainable.

b. **Task 2, Controlled-Burst Firing.** Using point targets, the automatic rifleman fires three-round bursts. This task exposes automatic riflemen to automatic fire and the action of the weapon and at the same time introduces trigger control.

c. **Task 3, NBC Traverse and Search Fire.** This task requires the automatic rifleman to make body position changes to engage area targets in depth, to use controlled-burst firing, and to use a series of aiming points to disburse fire across the target, while in protective mask and gloves.

d. **Task 4, Traverse and Search Fire.** This task requires the automatic rifleman to make position changes to engage area targets with width and depth, to use controlled-burst firing, and to use a series of aiming points to disburse fire across the target.

e. **Task 5, Traverse and Search Fire.** This task exposes the automatic rifleman to a series of point targets, to controlled-burst fire, and to trigger control during timed conditions.

f. **Task 6, NBC Traverse and Search Fire.** This task requires the automatic rifleman to engage area targets with width and depth, while making position changes during timed conditions, and while in protective mask and gloves.

g. **Task 7, Traverse and Search Fire.** This task requires the automatic rifleman to make position changes to engage area targets in depth during timed conditions.

5-24. 10-METER CONDUCT OF FIRE

The automatic riflemen are instructed on the objectives and fundamentals of firing from the bipod-supported prone and fighting positions, on fire commands used on the basic range, on the basic machine gun marksmanship target, and on analyzing and scoring the target. The unit is organized in firing orders based on range constraints. Each firing order should consist of an automatic rifleman and a coach. The coach assists the automatic rifleman during prefire checks and zeroing. He also relays signals to the tower operator, checks the automatic rifleman's position, and coaches him. During qualification, a coach is not used. The seven tasks are fired in the following manner.

a. **Task 1, Zeroing.**

(1) The automatic rifleman prepares the rear sight for zeroing and checks the front sight.

(2) The automatic rifleman assumes a good position.

(3) The tower operator instructs the automatic rifleman to prepare a single round.

(4) The following fire command is given. The automatic rifleman and coach repeat each element of the fire command as it is given.

AUTOMATIC RIFLEMAN (The automatic rifleman loads and moves safety to FIRE)

FRONT (Focuses on target or target area)

PASTER ONE (Locates target)

SEVEN HUNDRED (Adjusts sights and acquires sight picture)

FIXED, ONE ROUND (Method of fire)

COMMENCE FIRING (Fires on command of tower operator, but when ready)

NOTE: Throughout all firing exercises, the automatic rifleman performs the appropriate tasks during each element of the fire command. The number of rounds fired is used instead of the rate for METHOD OF FIRE. This is for control. (Omitting the rate specifies RAPID fire which is not desirable for the tasks.)

(5) The automatic rifleman loads one round, obtains the proper sight picture, and gives an UP to the coach.

(6) The coach relays the READY signal to the tower operator.

(7) The tower operator gives the command COMMENCE FIRING.

(8) The automatic rifleman engages paster 1 with three single shots when he is ready.

(9) The automatic rifleman moves downrange to observe, mark, and triangulate the shot group. Sight adjustments using the rear peep sight and windage knob are made at this time if the shot group is tight enough. If not, the automatic rifleman should fire another three rounds to ensure he has mastered the fundamentals before adjusting the sights.

(10) Steps 2 through 8 are repeated, but the automatic rifleman fires at paster 2.

NOTE: If the automatic rifleman zeros his weapon using 9 rounds, he uses the remaining 3 to confirm his zero. If he is unable to zero with 12 rounds, he is removed from the firing line for remedial training.

b. Task 2, Controlled-Burst Firing.

(1) The tower operator instructs the automatic rifleman to prepare a 6-round belt.

(2) When the fire command is given, the automatic rifleman and coach repeat each element as it is given.

AUTOMATIC RIFLEMAN
FRONT
PASTER THREE
SEVEN HUNDRED
FIXED, THREE-ROUND BURSTS
AT MY COMMAND

(3) The automatic rifleman acquires the proper sight picture and gives an UP to the coach.

(4) The coach relays the READY signal to the tower operator.

(5) The tower operator gives the command to FIRE.

(6) The automatic rifleman fires the first burst of three rounds at paster 3.

(7) Steps 2 through 6 are repeated, but the automatic rifleman fires at paster 4.

c. Task 3, NBC Traverse and Search Fire.

(1) The tower operator instructs the automatic rifleman to prepare a 15-round belt.

(2) The tower operator gives the order to mask by stating GAS. Once the soldiers are masked and have their gloves on, he gives the fire command.

(3) When the fire command is given, the automatic rifleman and coach repeat each element as it is given.

AUTOMATIC RIFLEMAN
FRONT
PASTERS FIVE THROUGH SIX
SEVEN HUNDRED
TRAVERSE AND SEARCH, THREE-ROUND BURSTS
AT MY COMMAND

(4) The automatic rifleman acquires the proper sight picture and gives an UP to the coach.

(5) The coach relays the READY signal to the tower operator.

(6) The tower operator gives the command to FIRE.

(7) Using the traverse and search technique, the automatic rifleman engages pasters 5 through 6, firing a three-round burst for each paster. Once complete, the soldiers are given the order ALL CLEAR.

(8) The automatic rifleman restores his mask to the carrier, removes his gloves, and moves downrange to observe and analyze his targets.

d. Task 4, Traverse and Search Fire.

(1) The tower operator instructs the automatic rifleman to prepare a 24-round belt.

(2) When the fire command is given, the automatic rifleman and coach repeat each element as it is given.

AUTOMATIC RIFLEMAN

FRONT

PASTERS SEVEN THROUGH EIGHT

SEVEN HUNDRED

TRAVERSE AND SEARCH, THREE-ROUND BURSTS

AT MY COMMAND

(3) The automatic rifleman acquires the proper sight picture and gives an UP to the coach.

(4) The coach relays the READY signal to the tower operator.

(5) The automatic rifleman engages pasters 7 through 8, firing a three-round burst at each paster, using the traverse and search technique.

(6) The automatic rifleman may move downrange to observe and analyze his targets.

e. Task 5, Traverse and Search Fire.

(1) The tower operator instructs the automatic rifleman to prepare a 12-round belt.

(2) When the fire command is given, the automatic rifleman and coach repeat each element as it is given.

AUTOMATIC RIFLEMAN

FRONT

PASTERS ONE THROUGH FOUR

SEVEN HUNDRED

FIXED, THREE-ROUND BURSTS

AT MY COMMAND

(3) The automatic rifleman acquires the proper sight picture and gives an UP to the coach.

(4) The coach relays the READY signal to the tower operator.

(5) The tower operator gives the command to FIRE.

(6) The automatic rifleman engages pasters 1 through 4 in 20 seconds, firing a three-round burst at each paster.

(7) The automatic rifleman may move downrange to observe and analyze his targets.

f. Task 6, NBC Traverse and Search Fire.

(1) The tower operator instructs the coach to prepare a 24-round belt.

(2) The tower operator gives the order to mask by stating GAS. Once the soldiers are masked and have their gloves on, he gives the fire command.

(3) When the fire command is given, the automatic rifleman and coach repeat each element of as it is given.

AUTOMATIC RIFLEMAN

FRONT

PASTERS SEVEN THROUGH EIGHT

SEVEN HUNDRED

TRAVERSE AND SEARCH, THREE-ROUND BURSTS

AT MY COMMAND

(4) The automatic rifleman acquires the proper sight picture and gives an UP to the coach.

(5) The coach relays the READY signal to the tower operator.

(6) The tower operator gives the command to FIRE.

(7) Using the traverse and search technique, the automatic rifleman engages pasters 7 through 8 in 40 seconds, firing a three-round burst at each paster. Once complete, the soldiers are given the order ALL CLEAR.

(8) The automatic rifleman restores his mask to the carrier, removes his gloves, and moves downrange to observe and analyze his targets.

g. Task 7, Traverse and Search Fire.

(1) The tower operator instructs the automatic rifleman and coach to prepare a 15-round belt.

(2) When the fire command is given, the automatic rifleman and coach repeat each element as it is given.

AUTOMATIC RIFLEMAN

FRONT

PASTERS FIVE THROUGH SIX

SEVEN HUNDRED

TRAVERSE AND SEARCH, THREE-ROUND BURSTS

AT MY COMMAND

(3) The automatic rifleman acquires the proper sight picture and gives an UP to the coach.

(4) The coach relays the READY signal to the tower operator.

(5) Using the traverse and search technique, the automatic rifleman engages pasters 5 through 6 in 40 seconds, firing a three-round burst at each paster.

(6) The automatic rifleman may move downrange to observe and analyze his target, and the coach scores it.

Basic (10-Meter) Firing Prone Position and Fighting Position, Bipod-Supported Practice and Qualification					
TASK	TIME	RDS	TYPE	TARGET	TYPE FIRE
1	No limit	12	Ball	Pasters 1 and 2	3 Single-round shot group
2	No limit	6	Ball	Pasters 3 and 4	3-round burst each paster
3X	No limit	15	Ball	Pasters 5 through 6	3-round burst each paster traverse and search
4	No limit	24	Ball	Pasters 7 through 8	3-round burst each paster traverse and search
*5	20 sec	12	Ball	Pasters 1 through 4	3-round burst each paster traverse and search
*6X	40 sec	24	Ball	Pasters 7 through 8	3-round burst each paster traverse and search
*7	40 sec	15	Ball	Pasters 5 through 6	3-round burst each paster traverse and search

NOTE: The unit commander determines the position to be used. A summary of the ammunition requirements is on page 5-50.

* Indicates qualification tasks.
 X Indicates tasks fired with protective mask and gloves as a minimum.

Table 5-1. Firing Table I.

5-25. 10-METER FIRING, QUALIFICATION

The first phase of qualification consists of firing Tasks 2 through 4 of Firing Table I for practice, and Tasks 5 through 7 of Firing Table I for record. Before firing, all soldiers must be familiar with the tasks, the time allowed, the ammunition allowances, the procedures to follow in the event of a stoppage, and the penalties imposed.

a. **Time and Ammunition.** Each automatic rifleman completes zeroing before record firing. Individual fire commands are given for each task. Task 5 is fired in 20 seconds; Task 6 in 40 seconds; and Task 7 in 40 seconds.

b. **Stoppages.** If a stoppage occurs, the automatic rifleman must apply immediate action. If the stoppage is reduced, he continues to fire the course.

(1) If a stoppage occurs that cannot be reduced by immediate action, the automatic rifleman raises his hand and awaits assistance.

(2) Once the stoppage is reduced, the automatic rifleman completes firing beginning with the next task.

(3) If a stoppage is caused by an error on the part of the automatic rifleman, additional time is not permitted. The automatic rifleman receives the score he earned before the stoppage occurred.

(4) If it is necessary to replace the M249 AR, the automatic rifleman must zero the new weapon. He may refire the exercise.

(5) Automatic riflemen who cannot fire a task or cannot complete firing in the time allowed (because of malfunctions) can finish the exercise in an "alibi run" after all other automatic riflemen complete firing. They fire only those tasks they failed to engage because of the malfunction.

c. **Penalties.** Five points are deducted from the score of any automatic rifleman who fails to stop firing at the command or signal to cease fire. If an automatic rifleman fires at the wrong target or exercise, he loses the points for those rounds. An automatic rifleman whose target was fired upon by another automatic rifleman is permitted to refire the exercise.

d. **Scoring.** Scores are tabulated IAW paragraph 5-20, see page 5-26. Automatic riflemen do not score their own targets when firing for qualification. During qualification firing, at least 35 points must be achieved on Firing Table I. DA Form 7304-R is used to record scores (see paragraph 5-30, page 5-50).

e. **Position.** Based on his METL, the commander selects either the bipod-supported prone position or bipod-supported fighting position for qualification.

5-26. TRANSITION FIRING

Transition firing provides the automatic rifleman the experience necessary to progress from 10-meter firing to field firing at various types of targets at longer ranges. The automatic rifleman experiences and learns the characteristics of fire, field zeroing, and range determination. He uses the adjusted aiming-point method of fire adjustment. Transition firing is conducted on a machine gun transition range or the MPRC. These exercises are fired with the bipod from the prone or fighting position. Transition firing is fired and scored for practice and

qualification to provide feedback to the automatic rifleman. Firing Table II consists of eight tasks (Table 5-2, page 5-42).

a. **Range Facilities.** The transition range should consist of several firing lanes. Each lane should be 10 meters wide at the firing line and 100 meters wide at a range of 800 meters. Ideally, each lane has a fighting position with an adjacent prone firing position.

b. **Targets.** Two target configurations using E-type silhouette targets may be used—single or double. The double represents an enemy automatic weapon, which for the automatic rifleman is a priority target (Figure 5-20). The targets are at various ranges that an automatic rifleman might engage. All targets should be plainly seen from the firing positions. Electrical targets are desirable.

c. **Stoppage.** The same procedures used in Firing Table I qualification firing are used (page 5-37).

d. **Penalties.** The same procedures used in Firing Table I qualification firing are used (page 5-37).

e. **Scoring.** Five points are given for each target hit, whether hit on the first or second burst. The total possible points is 55. The automatic rifleman must hit at least 7 (35 points) targets out of 11 exposures to qualify. DA Form 7304-R is used to record scores (see paragraph 5-30, page 5-30).

f. **Position.** Based on his METL, the commander selects either the bipod-supported prone position or the bipod-supported fighting position for qualification.



Figure 5-20. Single E-type and double E-type silhouette targets.

5-27. TRANSITION CONDUCT OF FIRE

The unit is organized in firing orders based on range constraints. Each firing order should consist of an automatic rifleman and a coach. The coach assists the automatic rifleman during prefire checks and zeroing. He also relays signals to the tower operator, checks the automatic rifleman's position, and coaches him except during qualification. The bipod-supported prone and fighting positions are used. The eight tasks are fired in the following manner.

a. **Task 1, Field Zeroing the 300-Meter, Single E-Type Silhouette.**

(1) The automatic rifleman prepares his rear sight for field zeroing and checks the front sight post. He sets the range to the zero target on the elevation knob. The preferred range is 300 meters.

(2) The automatic rifleman assumes a good position.

(3) The tower operator instructs the automatic rifleman to prepare a 12-round belt.

(4) When the fire command is given, the automatic rifleman and coach repeat each element as it is given.

AUTOMATIC RIFLEMAN

FRONT

TARGETS: TROOPS IN THE OPEN

THREE HUNDRED

FIXED, THREE-ROUND BURSTS

COMMENCE FIRING

(5) The automatic rifleman loads one 12-round belt of ammunition, obtains the proper sight picture, and gives an UP to the coach.

(6) The coach relays the READY signal to the tower operator.

(7) The tower operator gives the command COMMENCE FIRING.

(8) The automatic rifleman fires a three-round burst at the target when ready.

(9) The automatic rifleman observes the beaten zone. If the rounds miss the target, he makes adjustments for windage and elevation.

(10) After adjustments have been made, the automatic rifleman repeats steps 8 through 9 with the remaining rounds until rounds are impacting on the target. He records his zero.

b. **Task 2, 200-Meter, Single E-Type Silhouette.**

(1) The tower operator instructs the automatic rifleman to load one 66-round belt.

(2) When the fire command is given, the automatic rifleman and coach repeat each element as it is given. It is only given once for Tasks 2 through 8.

AUTOMATIC RIFLEMAN

FRONT

TARGET: TROOPS IN THE OPEN

ONE HUNDRED TO FOUR HUNDRED METERS

FIXED, THREE-ROUND BURSTS

AT MY COMMAND

- (3) The automatic rifleman gives an UP to the coach.
- (4) The coach gives the READY signal to the tower operator.
- (5) The tower operator gives the command FIRE.
- (6) The automatic rifleman scans the sector.
- (7) A 200-meter, single E-type target is exposed for 5 seconds.
- (8) The automatic rifleman determines the range, places the proper setting on the rear sight, assumes the proper position, obtains the correct sight alignment and sight picture, and fires a three-round burst.
- (9) If the automatic rifleman fails to hit the target, he fires another three-round burst using the adjusted aiming point method of fire adjustment.

c. Task 3, 400-Meter, Double E-Type Silhouette.

- (1) Automatic rifleman continues to scan the sector.
- (2) A 400-meter, double E-type target is exposed for 10 seconds.
- (3) The automatic rifleman determines the range, places the proper setting on the rear sight, assumes the proper position, obtains the correct sight alignment and sight picture, and fires a three-round burst.
- (4) If the automatic rifleman fails to hit the target, he fires another three-round burst using the adjusted aiming point method of fire adjustment.

d. Task 4, 100-Meter, Single E-Type Silhouette.

- (1) The tower operator gives the order to mask by stating GAS. The automatic rifleman and coach put on their masks and gloves.
- (2) The automatic rifleman continues to scan the sector.
- (3) A 100-meter, single E-type target is exposed for 10 seconds.
- (4) The automatic rifleman determines the range, places the proper setting on the rear sight, assumes the proper position, obtains the correct sight alignment and sight picture, and fires a three-round burst.
- (5) If the automatic rifleman fails to hit the target, he fires another three-round burst using the adjusted aiming point method of fire adjustment.

e. Task 5, 300-Meter, Single E-Type Silhouette.

- (1) The automatic rifleman continues to scan the sector, while in protective mask and gloves.
- (2) A 300-meter, single E-type target is exposed for 15 seconds.
- (3) The automatic rifleman determines the range, places the proper setting on the rear sight, assumes the proper position, obtains the correct sight alignment and sight picture, and fires a three-round burst.
- (4) If the automatic rifleman fails to hit the target, he fires another three-round burst using the adjusted aiming point method of fire adjustment.

f. Task 6, 100-Meter and 300-Meter, Single E-Type Silhouettes.

- (1) The automatic rifleman continues to scan the sector, while in protective mask and gloves.

(2) A 100-meter and a 300-meter, single E-type target are exposed for 20 seconds.

(3) The automatic rifleman determines the range, places the proper setting on the rear sight, assumes the proper position, obtains the correct sight alignment and sight picture, and fires a three-round burst at each target.

(4) If the automatic rifleman fails to hit the target, he fires another three-round burst using the adjusted aiming point method of fire adjustment at each target.

(5) The tower operator gives the order ALL CLEAR. The automatic rifleman and coach restore their masks to their carriers and remove their gloves.

g. Task 7, 200-Meter Single E-Type and 400-Meter Double E-Type Silhouettes.

(1) The automatic rifleman continues to scan the sector.

(2) The 200-meter single E-type and the 400-meter double E-type targets are exposed for 20 seconds.

(3) The automatic rifleman determines the range, places the proper setting on the rear sight, assumes the proper position, obtains correct sight alignment and sight picture, and fires a three-round burst at each target.

(4) If the automatic rifleman fails to hit the target, he fires another three-round burst using the adjusted aiming point method of fire adjustment at each target.

h. Task 8, 100- and 200-meter single E-type and 400-Meter Double E-Type Silhouettes.

(1) The automatic rifleman continues to scan the sector.

(2) The 100-meter and 200-meter single E-type and 400-meter double E-type targets are exposed for 25 seconds.

(3) The automatic rifleman determines the range, places the proper setting on the rear sight, assumes the proper position, obtains correct sight alignment and sight picture, and fires a three-round burst at each target.

(4) If the automatic rifleman fails to hit the target, he fires another three-round burst using the adjusted aiming point method of fire adjustment at each target.

Transition Firing Prone Position and Fighting Position, Bipod-Supported Practice and Qualification						
TASK	TIME	RDS	TYPE	TARGET	RANGE	TYPE FIRE
1	No limit	12	X 4:1	Single E	300	Fixed, 3-round burst (field zero)
*2	5 sec	6	X 4:1	Single E	200	Fixed, 3-round burst
*3	10 sec	6	X 4:1	Double E	400	Fixed, 3-round burst
*4	10 sec	6	X 4:1	Single E	100	Fixed, 3-round burst
*5	15 sec	6	X 4:1	Single E	300	Fixed, 3-round burst
*6	20 sec	12	X 4:1	Single E	100, 300	Fixed, 3-round burst
*7	20 sec	12	X 4:1	Single E	200	Fixed, 3-round burst
			X 4:1	Double E	400	Fixed, 3-round burst
*8	25 sec	18	X 4:1	Single E	100	Fixed, 3-round burst
			X 4:1	Single E	200	Fixed, 3-round burst
			X 4:1	Double E	400	Fixed, 3-round burst

NOTE: Unit commander determines the firing position. Tasks 4, 5, and 6 are fired with protective masks and gloves as a minimum. A summary of the ammunition requirements is on page 5-50.

* Indicates qualification tasks.
 X Indicates ball and tracer 4:1 mix.

Table 5-2. Firing Table II.

5-28. TRANSITION FIRING, LIMITED VISIBILITY

Night or limited visibility firing requires the soldier to apply the fundamentals of automatic rifle marksmanship while using the AN/PVS-4. This training instills confidence in the automatic rifleman. Each soldier learns how to engage targets

using the AN/PVS-4. He learns to mount the sight, boresight the weapon at 10 meters, and zero the AN/PVS-4 to the weapon at 25 meters. Finally, he learns to detect and engage a series of undetermined targets at various ranges with the AN/PVS-4. Night firing exercises can be conducted during daylight when the daylight cover is used. These exercises are for practice and instructional purposes only —**not for qualification**. The commander can use this training to assess his unit's METL. Night firing is conducted on a 10-meter range and the same transition range or a multipurpose machine gun range used for Firing Table II. There are no NBC engagements; otherwise, the tasks and conduct of fire in Firing Table III are the same as in Firing Table II except for range to the target and number of engagements. Therefore, a conduct of fire is not necessary.

a. **Time and Ammunition.** Firing Table III (page 5-49) outlines ammunition requirements. There is no time requirement.

b. **Stoppage.** The same procedures used in Firing Table I, page 5-37.

c. **Penalties.** No penalties are used.

d. **Scoring.** No points are used; commanders can use this training for assessment. DA Form 7304-R, provided in the back of this manual, can be used to record the number of hits.

e. **Conditions.** Firing Table III is for engaging targets out to 400 meters under ideal moonlight or during daylight conditions. If visibility is limited because of a lack of ambient light, commanders may use field-expedient means to identify targets.

f. **Targets.** Single E-type silhouette targets or double E-type silhouette targets are used.

g. **Position.** Based on his METL, the commander selects either the bipod-supported prone position or bipod-supported fighting position.

5-29. ZEROING THE AN/PVS-4

Zeroing aligns the AN/PVS-4 to the M249. The sight may be zeroed during daylight or darkness. (TM 11-5855 -213-10.) If done during daylight, the daylight cover must be used. To obtain a precise zero, it is best done at 300 meters and at night. Once an AN/PVS-4 has been zeroed on an M249 AR, any soldier who knows how to use the reticle should fire the weapon effectively. However, there may be some changes in zero when the objective focus is adjusted to engage targets at various ranges and when the diopter focus is adjusted for the vision of different firers. A metal target is excellent for zeroing purposes, because the strike of the round can be easily observed with an AN/PVS-4. The procedures to zero are as follows.

a. **Mounting the Bracket and Device.** Before zeroing and qualifying with the AN/PVS-4, the automatic rifleman must mount the bracket and sight onto his weapon.

CAUTION

When mounting an AN/PVS-4 to the mounting bracket, make sure that the hole for the screw in the AN/PVS-4 is aligned and flush against the bracket screw. If not, the screw will strip the threads in the screw hole of the AN/PVS-4 and prevent use with the M249 AR.

(1) Place the mounting bracket on top of the feed cover mechanism assembly so that the two forked ends are secured around the headless pins.

(2) Remove the screw cover behind the rear sight assembly, and screw the bracket knob in until it is tight.

(3) Position the AN/PVS-4 on top of the bracket so that the mount of the AN/PVS-4 is aligned with the mounting knob of the bracket.

(4) Turn the mounting knob clockwise until the AN/PVS-4 is tight (Figure 5-21).

b. **Seating the Device.** Once the device is mounted, the automatic rifleman fires a three-round burst to seat the device, checks and tightens the mounting knob, and then fires another three-round burst. He checks the device to ensure it is settled and securely fastened and tightens the mounting knob if necessary. He does not fire at the boresight target during this procedure.

c. **Centering the Reticle in the Field of View.** The automatic rifleman turns the device on and centers the reticle pattern in the field of view by using the azimuth and elevation actuators. To be accurate, he does this by rotating the elevation and azimuth actuators from one side to the other and from top to bottom, while counting the number of clicks. (The elevation actuator has the down direction marked DN with an arrow. This moves strike of the round. The azimuth actuator has the right direction marked with RT with an arrow. This also moves the strike of the round. He divides the number of clicks for each by two and moves the elevation and azimuth actuators that number of clicks. This manually centers the reticle in the field of view horizontally and vertically. This enables the automatic rifleman to reach an accurate boresight between the point of aim (reticle) and the center of the bore (Figure 5-22, page 5-46).

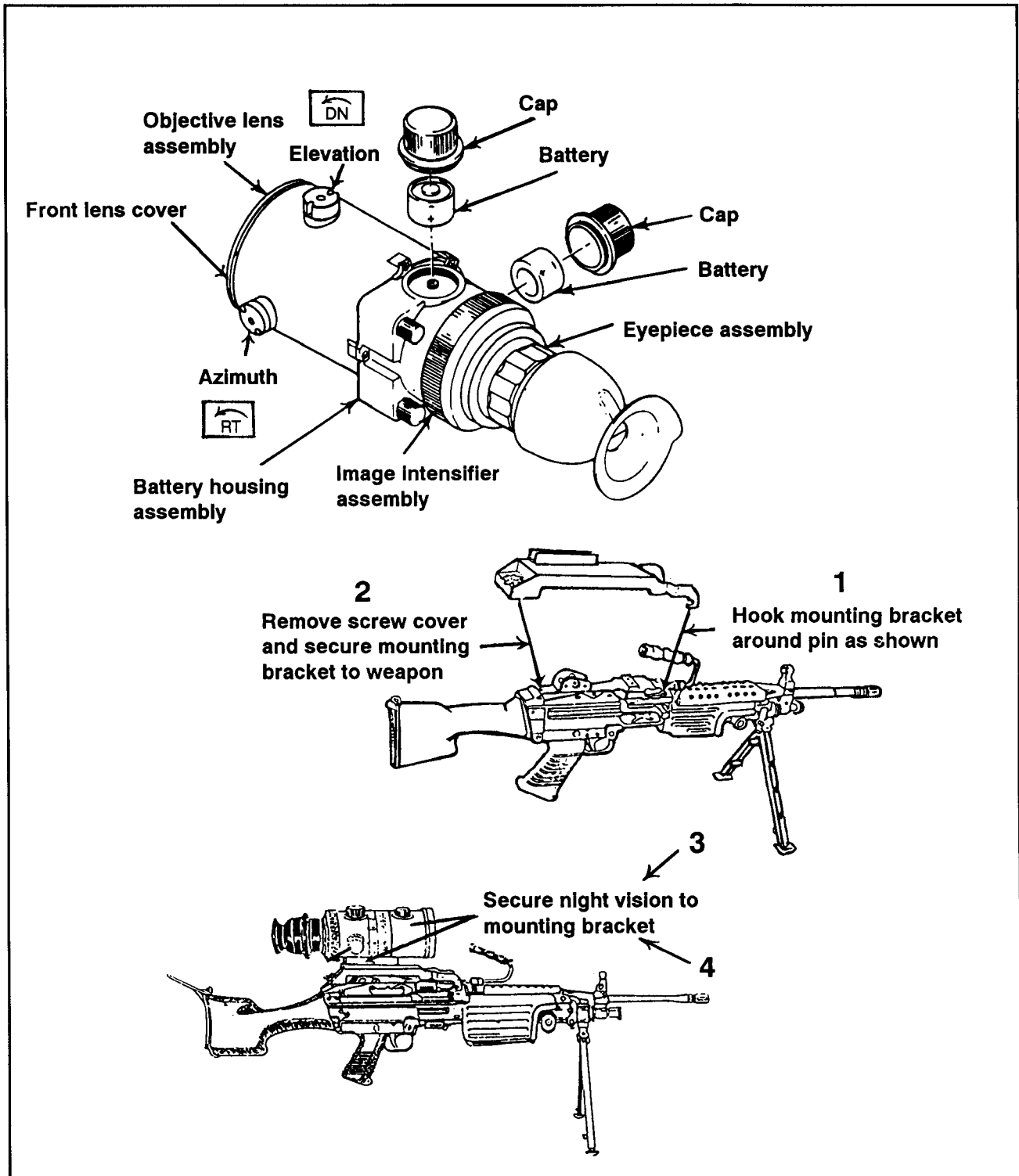

Figure 5-21. Mounting the AN/PVS-4.

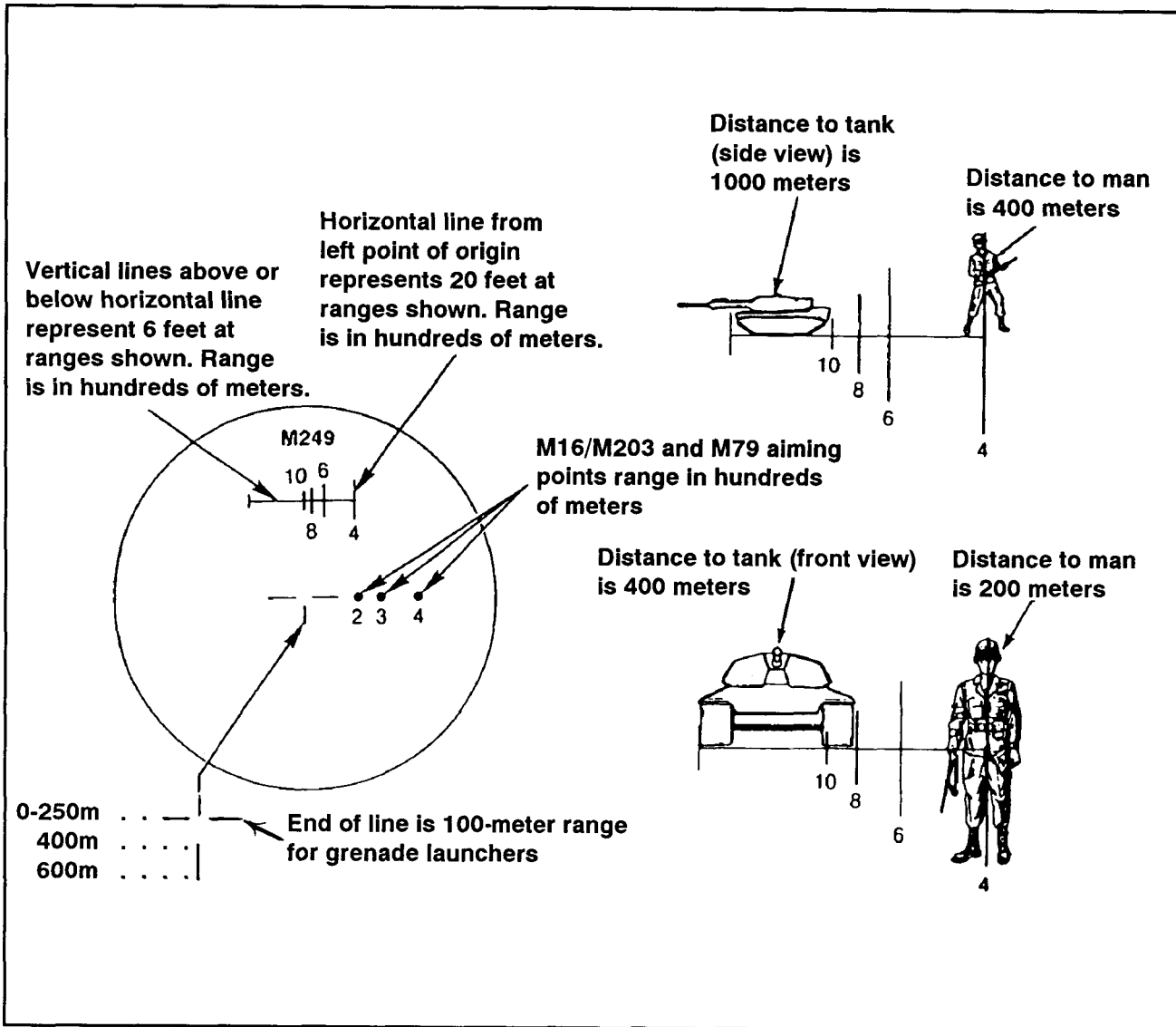

Figure 5-22. Centered reticle pattern.

d. **Confirming the Boresight.** To do this, the automatic rifleman centers and affixes a 25-meter (M16A2) zero target to the back of a basic machine gun paster target. This provides a large, clear surface for identifying the strike of the round. Then, he emplaces the target 10 meters from the firing position. The automatic rifleman places the reticle aiming point on the 25-meter zero target aiming point (Figure 5-23) and fires a single round. If the round impacts anywhere near the aiming point, he fires two more rounds to establish his group.

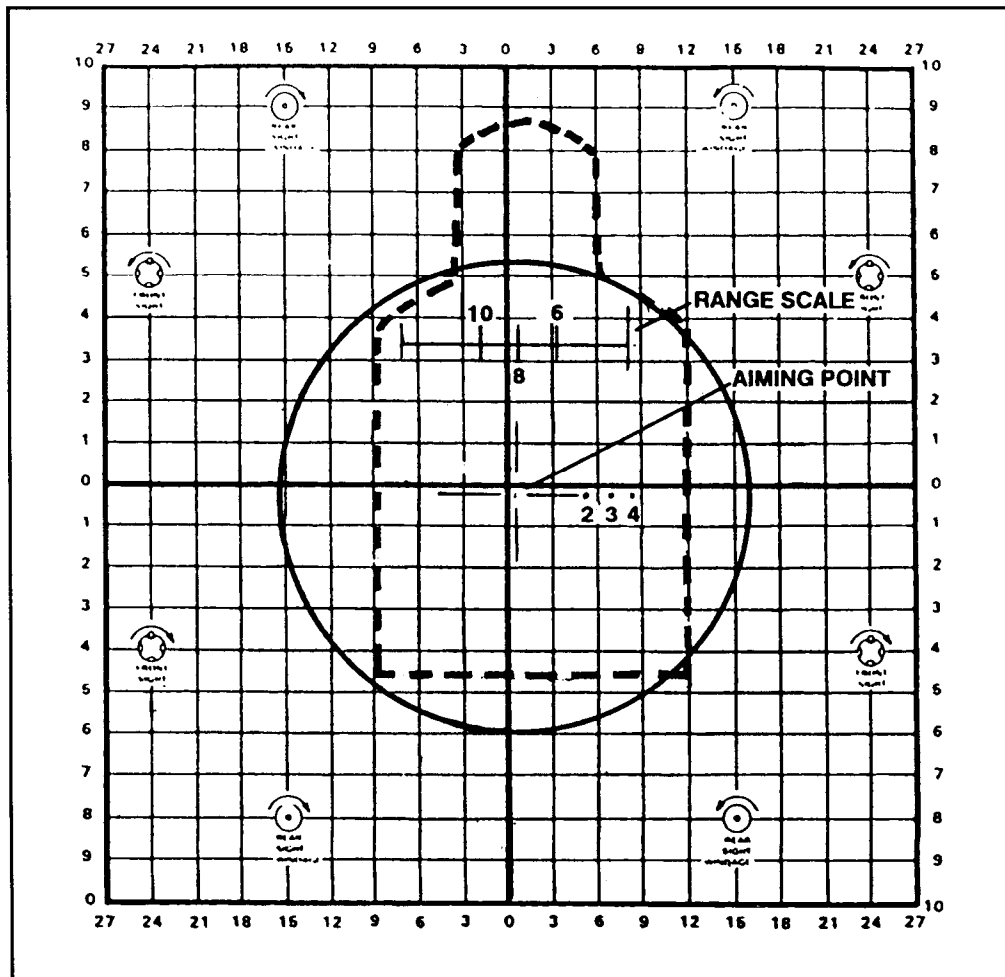

Figure 5-23. Reticle aiming point and the target aiming point.

e. **25-Meter Zeroing.** After a boresight has been established, the automatic rifleman moves back to a 25-meter firing position. He affixes another 25-meter zero target to the back of a 10-meter machine gun target and fires three rounds.

(1) Locate and triangulate the center of the shot group. From the center of the shot group, adjust the reticle to move the center of the shot group to a point 8 cm below and 2 cm right of the target aiming point (Figure 5-24, page 5-48). This location on the 25-meter zero target is 9 squares below (8 cm divided by .9) and 2 squares right (2 cm divided by .9) of the target aiming point. Make the adjustment using the AN/PVS-4 azimuth and elevation adjustment actuators. Each square on the 25-meter zero target is .9 cm. Each click of the actuators moves the strike of the round .25 cm (or .1 inch) at 10 meters.

Therefore, 4 clicks on either the elevation or azimuth actuator moves the strike of the round one square.

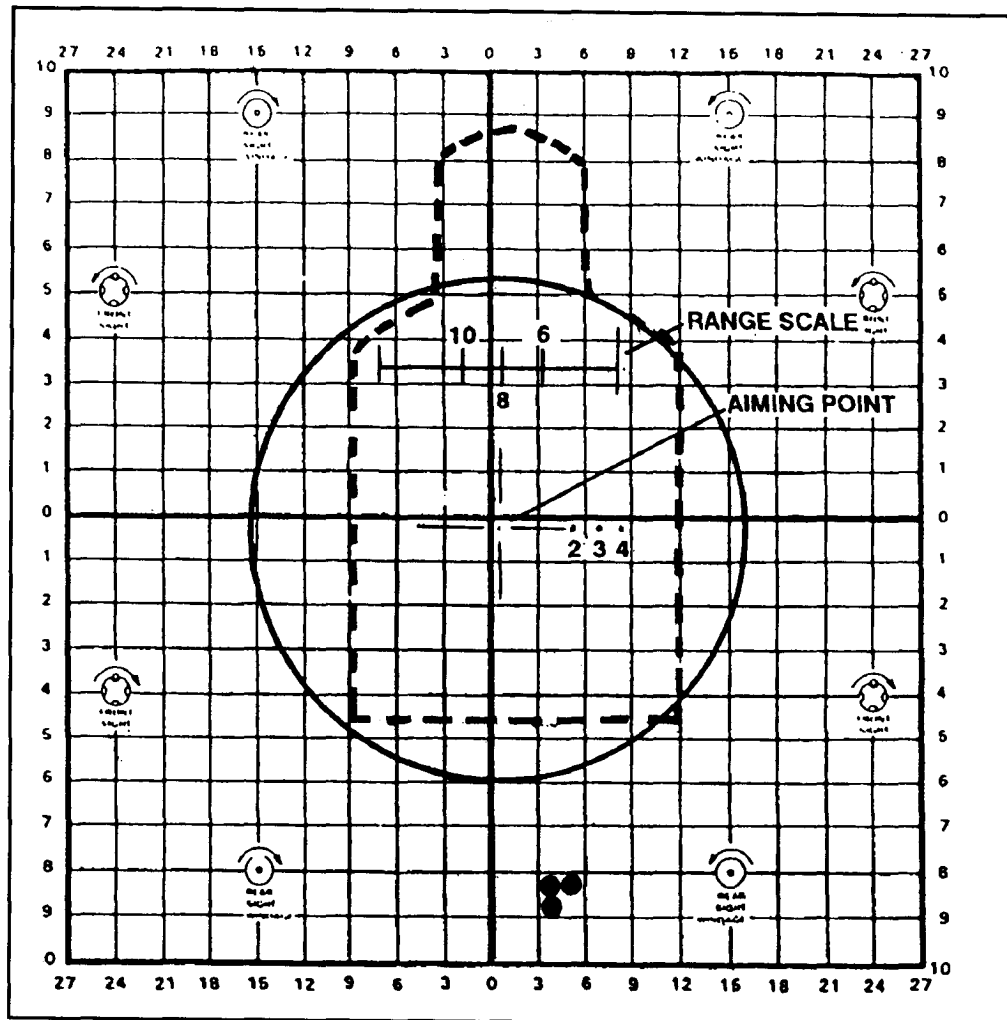

Figure 5-24. Shot group.

(2) After making the adjustments, assume a stable position, place the reticle aiming point on the target aiming point, and fire three more single rounds. Repeat the process until the rounds impact within the desired location (9 squares below and 2 squares right).

(3) If you miss the 25-meter zero target with the first round but strike the 10-meter machine gun paster target, make a large adjustment with the elevation and azimuth actuators. Continue this process with three-round groups and adjustments until the rounds strike the desired location.

NOTE: The zero is not recorded because when the AN/PVS-4 is dismounted and remounted on the same M249, some changes may occur. It is best to zero each time.

(4) Once the AN/PVS-4 is mounted and boresighted, fire a three-round burst at the center base of the target and note the strike of the rounds. While maintaining the reticle aiming point on the target, move the reticle aiming point to the strike of the rounds by manipulating the elevation and azimuth actuators.

(5) Acquire a good sight picture on the target with the reticle aiming point once again and fire another three-round burst. Note the strike of the rounds and repeat the process until the rounds impact on target.

Transition Limited Visibility Firing Prone Position and Fighting Position, Bipod-Supported Practice and Instructional						
TASK	TIME	RDS	TYPE	TARGET	RANGE	TYPE FIRE
1	No limit	12	X 4:1	Single E	25	Fixed, 3-round burst (zero)
2		6	X 4:1	Single E	200	Fixed, 3-round burst
3		6	X 4:1	Double E	400	Fixed, 3-round burst
4		6	X 4:1	Single E	100	Fixed, 3-round burst
5		6	X 4:1	Single E	300	Fixed, 3-round burst
6		6	X 4:1	Single E	100	Fixed, 3-round burst

NOTE: Unit commander determines the firing position. Boresighting requires 12 rounds, and seating the device requires 6 rounds. A summary of the ammunition requirements is on page 5-50.

X Indicates ball and tracer 4:1 mix.

Table 5-3. Firing Table III.

5-30. QUALIFICATION STANDARDS

Qualification with the M249 AR consists of achieving the minimum standards for 10-meter day and transition day firing tables. One point is allowed for each round impacting within the scoring space (maximum of 3 for each space) for Firing Table I. For Firing Table II, 5 points are allowed for each target hit whether the target is hit on the first or second burst. The maximum possible score for Firing Table I is 51 points. A minimum of 35 points is required. The maximum score for Table Firing II is 55 points; at least 35 points must be scored on this table to qualify. The minimum total score is 70; the maximum total score is 106. The overall ratings are as follows:

EXPERT	90-106
AUTOMATIC RIFLEMAN 1st CLASS	80-89
AUTOMATIC RIFLEMAN 2d CLASS	70-79
UNQUALIFIED	0-69

The trainer uses DA Form 7304-R (Scorecard for M249 AR) for recording the automatic rifleman's performance on the M249 AR qualification range. The instructions for completing the scorecard are on its reverse side. An example of a completed form is in Figure 5-25. A blank locally reproducible form is in the back of this manual.

The following is a summary of ammunition required:

TABLE	ROUNDS	TYPE
I Practice	57	Ball
I Record	51	Ball
II Practice	78	4:1
II Record	66	4:1
III Instructional	60	4:1
III Practice	36	4:1

NOTE: See DA Pam 350-38 for STRAC ammunition requirements.

SCORECARD FOR M249 AR															
For use of this form, see FM 23-14; the proponent agency is TRADOC															
SEE BACK OF THIS FORM FOR INSTRUCTIONS															
1. NAME DIXON, WAYNE B PFC				2. SSN 123-45-6789				3. UNIT C Co 1/29th				4. DATE Oct 19, 1993		5. LANE 1	
6. TABLE I (10-METER W/NBC)				7. TABLE II (DAY TRANSITION W/NBC)						8. TABLE III					
TASK	RANGE (METERS)	TIME	HITS POINTS	TASK	RANGE (METERS)	TIME	**PRAC HIT MISS		**QUAL HIT MISS		TASK	RANGE (METERS)	PRAC/INSTR HIT MISS		
1*	10	N/A	N/A	1*	300	N/A	N/A	N/A	N/A	N/A	1*	25	N/A	N/A	
2*	10	N/A	N/A	2	200	5 sec	X		X		2*	200	X		
3*	10	N/A	N/A	3	400	10 sec	X		X		3*	400	X		
4*	10	N/A	N/A	4	100	10 sec	X		X		4*	100	X		
5	10	20 sec	9	5	300	15 sec	X		X		5*	300	X		
6	10	40 sec		21	6	100 300	20 sec	X			0	6*	100	X	
7	10	40 sec	12		7	200 400	20 sec	X		X			N/A		
					8	100 200 400	25 sec	X		X			N/A		
								X		X					5
9. TOTAL 42				*NONSCORED TASKS ** 5 POINTS PER HIT				TOTAL 40				TOTAL SCORE 82			
EXPERT 90 - 106				FIRST CLASS 80 - 89				SECOND CLASS 70 - 79							
10. OIC SIGNATURE CPT J.P. Shutt				11. GRADER SIGNATURE SSG C. Britt				12. RATING AUTOMATIC RIFLEMAN 1st CLASS							
<p>AUTHORITY: 10USC30129(g) Executive Order 9397. PRINCIPAL PURPOSE(S): Records Individual's performance on record fire range. ROUTINE USE(S): Evaluation of Individual's proficiency and basis for determination of award of proficiency badge; SSN is used for positive identification purposes only MANDATORY OR VOLUNTARY DISCLOSURE AND EFFECT ON INDIVIDUAL NOT PROVIDING INFORMATION: Voluntary, individuals not providing information cannot be rated/scored on a mass basis.</p>															

Figure 5-25. Example of completed M249 AR scorecard, front.

Figure 5-25. Example of completed M249 AR scorecard, back; continued.

The following procedures will be used to fill out the scorecard.

1. NAME: Enter last name, first name, middle initial, and rank.
2. SSN: Enter automatic rifleman's social security number.
3. UNIT: Enter unit designation.
4. DATE: Enter date of firing.
5. LANE: Enter the lane number for the firing point of the automatic rifleman.
6. HIT: For Firing Table I, enter the number of rounds impacting within the spaces in Tasks 5 through 7.
7. HIT: For Firing Table II, enter an X for a hit and enter an 0 for a miss for Tasks 2 through 8.
8. HIT: (NOT FOR QUALIFICATION, USE FOR PRACTICE AND INSTRUCTION) For Firing Table III, enter an X for a hit a an 0 for a miss for Tasks 2 through 6.

9. POINTS FOR FIRING TABLES I AND II: For Firing Table I, enter 1 point for each round impacting within the scoring space (maximum of seven for each space) in Tasks 5 through 7. For Firing Table II, enter 20 points for each target hit in tasks 2 through 8 whether target is hit on the first or second burst.

TOTAL SCORE: Enter the total of combined points. The automatic rifleman must score 35 points on Firing Table I and 35 points on Firing Table II to meet the minimum score on each. The following qualification levels are provided:

EXPERT	90 - 106
AUTOMATIC RIFLEMAN 1ST CLASS	80 - 89
AUTOMATIC RIFLEMAN 2D CLASS	70 - 79
UNQUALIFIED	0 - 69

10. OIC SIGNATURE: OIC's signature.
11. GRADER SIGNATURE: Grader's signature.
12. RATING: Enter automatic rifleman's rating of performance.

CHAPTER 6

COMBAT TECHNIQUES OF FIRE

The technique of fire is the method of delivering and controlling effective fire. The automatic rifleman must be trained in the standard methods of applying fire. This chapter discusses combat techniques of fire, application of fire on the battlefield, and advanced marksmanship. (See Appendix E for tactical employment.)

Section I. INTRODUCTION

Before the automatic rifle can be employed to its full potential, the soldier must know and be trained on characteristics of fire, classes of fire, types of targets, and application of fire.

6-1. CHARACTERISTICS OF FIRE

Each automatic rifleman must know the effects of bullets when fired. Factors influencing the path and strike of rounds are not limited to applying the fundamentals. They include the velocity of the round, gravity, terrain, atmospheric conditions, and the innate differences between each round.

a. **Trajectory.** The trajectory is the path of the bullet in flight (Figure 6-1). The automatic rifleman must know the M249 AR's trajectory to effectively fire the weapon throughout its full range. The path of the bullet is almost flat at ranges up to 300 meters; then it begins to curve, and the curve becomes greater as the range increases.

b. **Maximum Ordinate.** This is the highest point the trajectory reaches between the muzzle of the weapon and the base of the target. It always occurs about two-thirds of the distance from the weapon to the target. The maximum ordinate increases as the range increases (Figure 6-1).

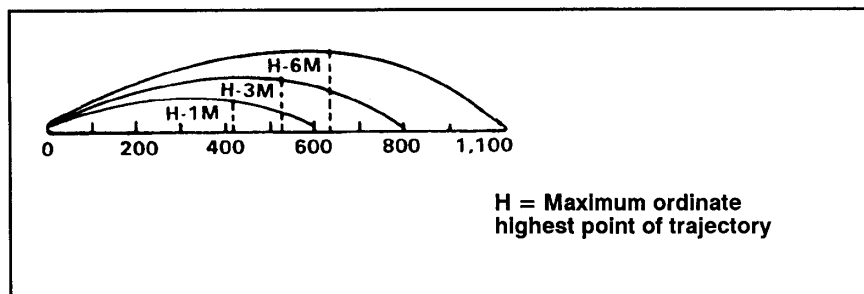

Figure 6-1. Trajectory and maximum ordinate.

c. **Cone of Fire.** When several rounds are fired in a burst from an M249 AR, each round takes a slightly different trajectory. The pattern these rounds form on the way to the target is called a cone of fire (Figure 6-2). This is caused primarily by vibration of the weapon and variations in ammunition and atmospheric conditions.

d. **Beaten Zone.** The beaten zone (Figure 6-2) is the elliptical pattern formed by the rounds striking the ground or the target. The size and shape of the beaten zone changes when the range to the target changes or when the weapon is fired on different types of terrain. On uniformly sloping or level terrain, the beaten zone is long and narrow. As the range to the target increases, the beaten zone becomes shorter and wider. When fire is delivered on terrain sloping down and away from the weapon, the beaten zone becomes longer. When fire is delivered on rising terrain, the beaten zone becomes shorter. The terrain has little effect on the width of the beaten zone.

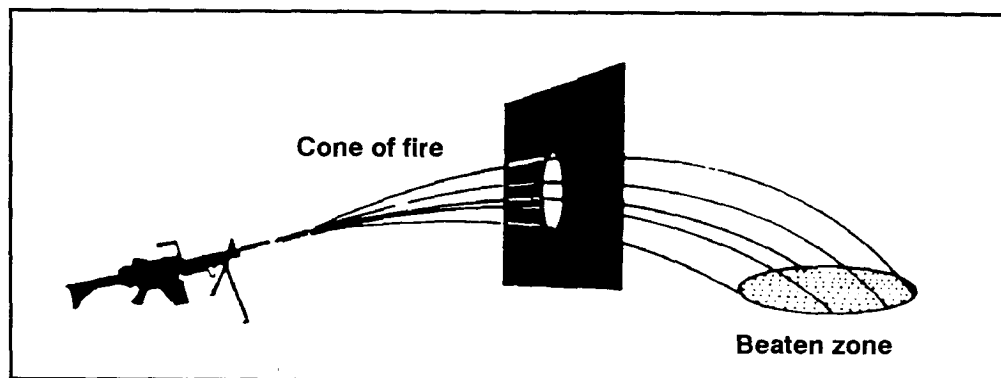

Figure 6-2. Cone of fire and beaten zone.

e. **Danger Space.** This is the space between the weapon and the target where the trajectory does not rise above 1.8 meters (the average height of a standing soldier). This includes the area of the beaten zone. When the M249 is fired on level or uniformly sloping terrain at a target less than 700 meters away, the trajectory will not rise above the average height of a standing soldier. When targets are engaged on level or uniformly sloping terrain at ranges greater than 700 meters, the trajectory will rise above the average height of a standing soldier. Therefore, not all the distance between the weapon and the target is danger space.

6-2. CLASSES OF FIRE

Automatic rifle fire is classified with respect to the ground, the target, and the weapon.

a. Fire with respect to the ground (Figure 6-3) includes grazing and plunging fires.

(1) *Grazing fire*. This occurs when the center of the cone of fire does not rise more than 1 meter above the ground. When firing on level or uniformly sloping terrain, the automatic rifleman can obtain a maximum of 600 meters of grazing fire.

(2) *Plunging fire*. This occurs when the danger space is confined to the beaten zone. Plunging fire occurs when firing at long ranges, from high ground to low ground, into abruptly rising ground, or across uneven terrain, resulting in a loss of grazing fire at any point along the trajectory.

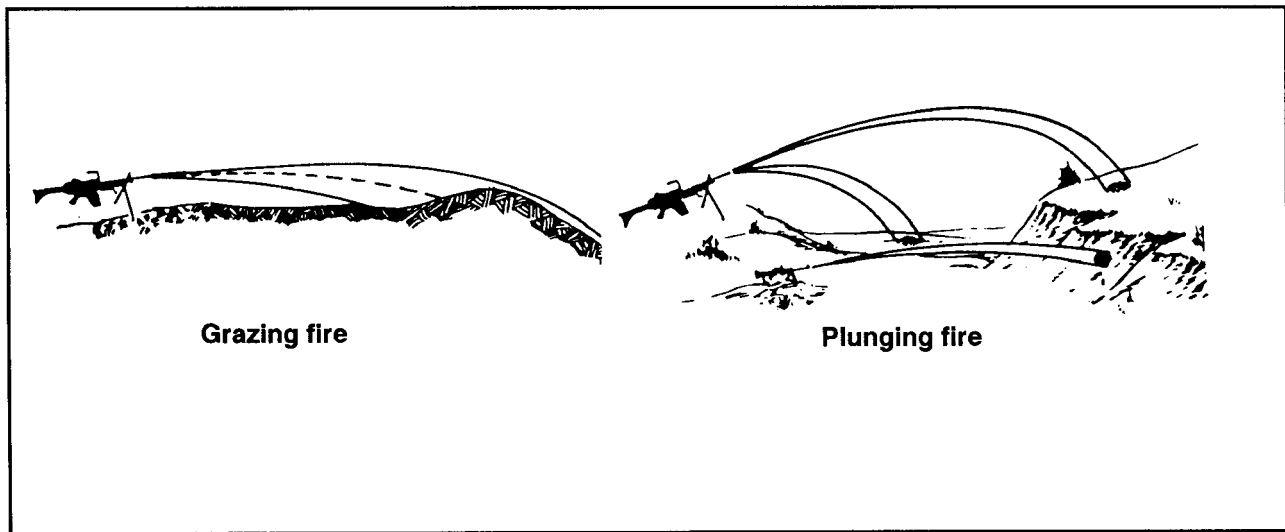

Figure 6-3. Classes of fire with respect to the ground.

b. Fire with respect to the target includes frontal, flanking, oblique, and enfilade fires.

(1) *Frontal fire*. This is when the long axis of the beaten zone is at a right angle to the front of the target. An example is when firing at the front of a target (Figure 6-4, page 6-4).

(2) *Flanking Fire*. This is firing at the side of a target (Figure 6-4).

(3) *Oblique fire*. This is when the long axis of the beaten zone is at an angle other than a right angle to the front of the target (Figure 6-5, page 6-4).

(4) *Enfilade fire*. This is when the long axis of the beaten zone coincides or nearly coincides with the long axis of the target. This type of fire is either frontal or flanking. It is the most desirable type of fire with respect to a target, because it makes maximum use of the beaten zone (Figure 6-5).

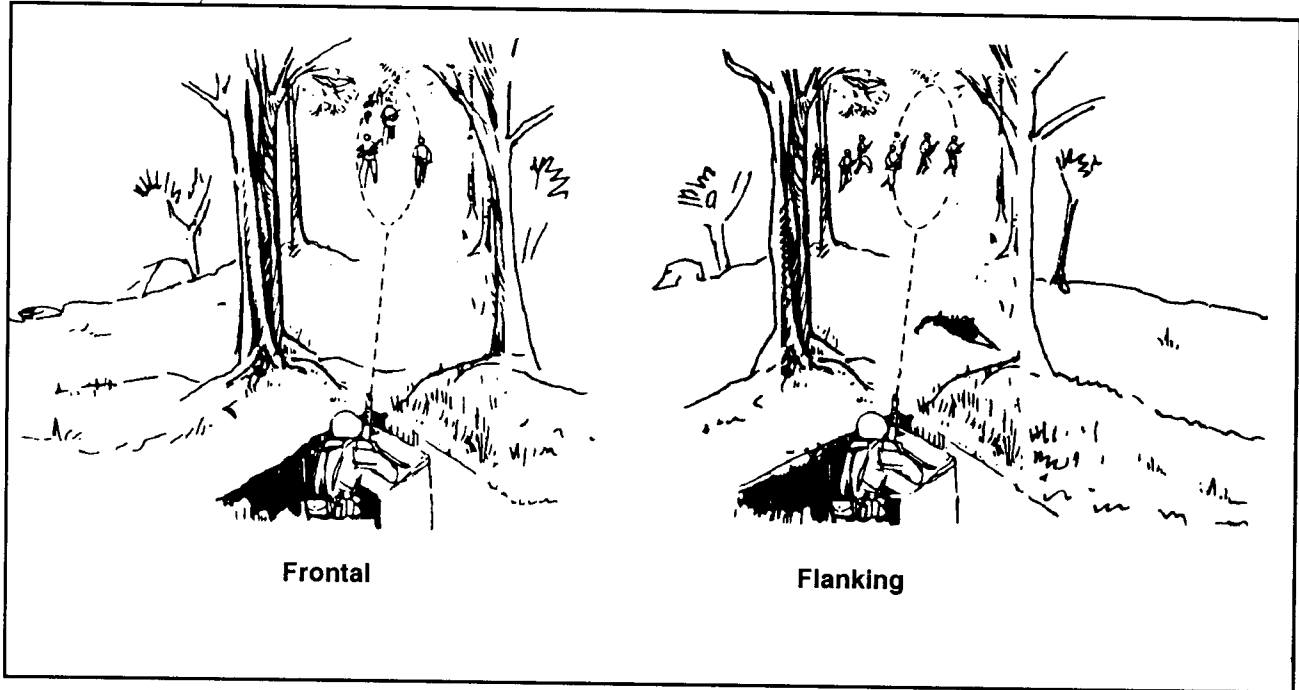

Figure 6-4. Frontal fire and flanking fire.

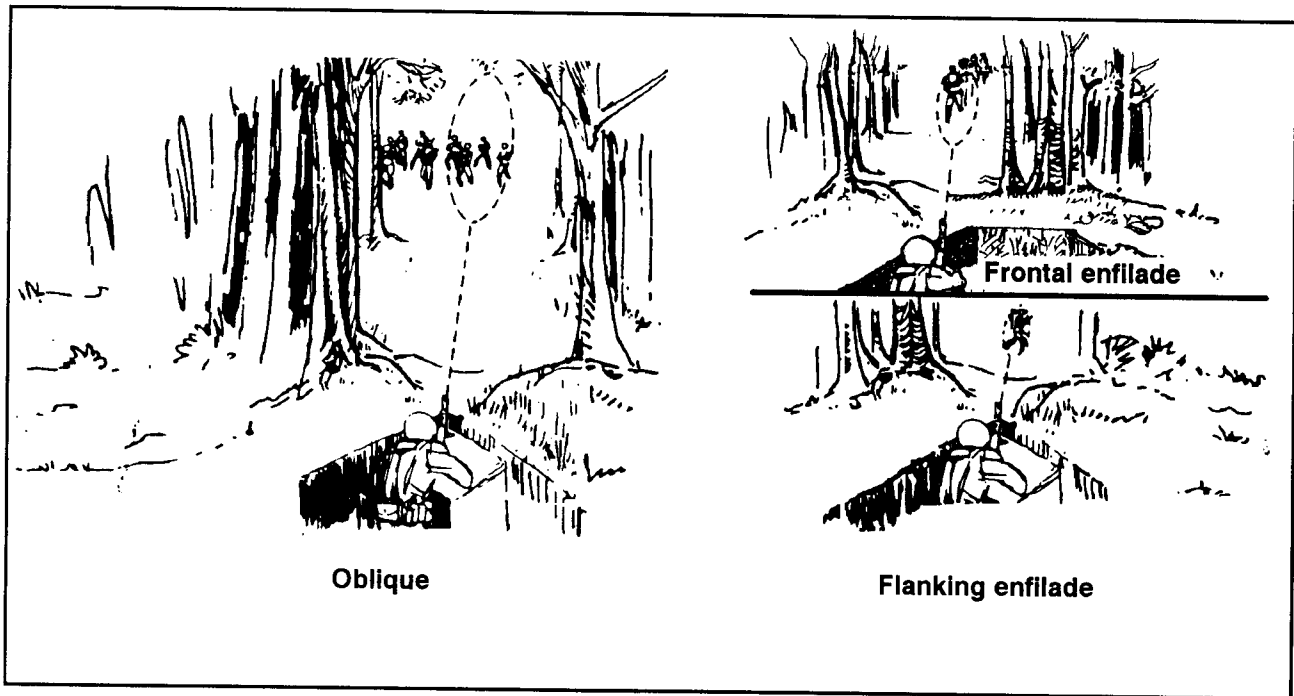

Figure 6-5. Oblique fire and enfilade fire.

c. Fire with respect to the **weapon** (Figure 6-6) includes fixed, traversing, searching, and traversing and searching fires.

(1) *Fixed fire.* This is fire delivered against a point target when the depth and width of the beaten zone will cover the target. This means only one aiming point is necessary to provide coverage of the target.

(2) *Traversing fire.* This is fire distributed in width by successive changes in direction. The automatic rifleman selects successive aiming points throughout the width of the target. These aiming points must be close enough to ensure adequate coverage but not so close to waste ammunition.

(3) *Searching fire.* This is fire distributed in depth by successive changes in elevation. The automatic rifleman selects successive aiming points in depth. The changes in each aiming point depends on the range and slope of the ground.

(4) *Traversing and searching fire.* This is fire distributed in width and depth by successive changes in direction and elevation. Combining traversing and searching fires provides good coverage of the target. Adjustments are made in the same manner as described for traversing and searching fire.

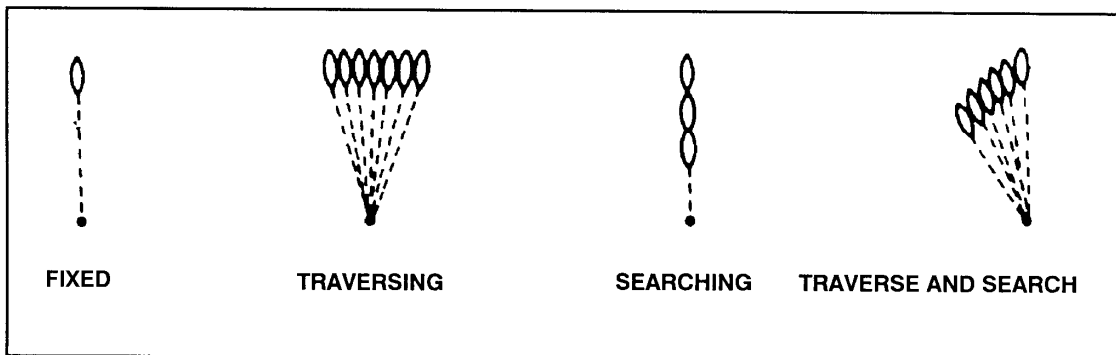

Figure 6-6. Classes of fire with respect to the weapon.

Section II. APPLICATION OF FIRE

Application of fire consists of the methods the automatic rifleman uses to cover a target area. Training these methods of applying fire can be accomplished only after the soldiers have learned how to recognize the different types of targets they may find in combat, how to distribute and concentrate their fire, and how to maintain the proper rate of fire. Normally, the automatic rifleman will be exposed to two types of targets in the squad sector: enemy soldiers and supporting automatic weapons. These targets have priority and should be engaged immediately.

6-3. TYPES OF TARGETS

Targets presented to the automatic rifleman in combat will usually be enemy troops in various formations, which will require distribution and concentration of fire. Targets with width and depth must be thoroughly covered by fire.

a. **Point Targets.** These require the use of a single aiming point. Examples of point targets are enemy soldiers, bunkers, weapons emplacements, and lightly armored vehicles. Fixed fire is delivered at point targets.

b. **Area Targets.** These may have considerable width and depth and may require extensive traversing and searching fire. These include targets in which the exact location of the enemy is unknown. The following are varieties of area targets likely to be engaged.

(1) Linear targets have sufficient width to require successive aiming points (traversing fire). The beaten zone effectively covers the depth of the target area (Figure 6-7). Traversing fire is delivered at linear targets.

(2) Deep targets require successive aiming points (searching fire) (Figure 6-8). Searching fire is delivered at deep targets.

(3) Linear targets with depth have sufficient width requiring successive aiming points in which the beaten zone does not cover the depth of the target area. A combined change in direction and elevation (traversing and searching) is necessary to effectively cover the target with fire (Figure 6-9). Traversing and searching fire is delivered at linear targets with depth.

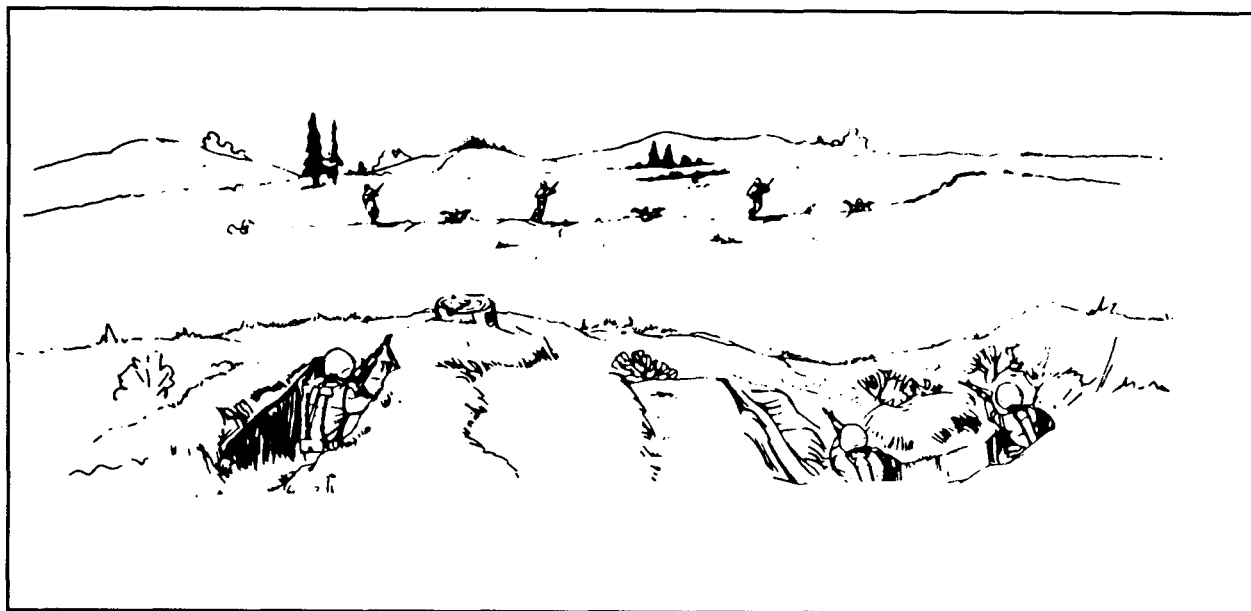

Figure 6-7. Linear target.



Figure 6-8. Deep target.



Figure 6-9. Linear targets with depth.

6-4. DISTRIBUTION, CONCENTRATION, AND RATE OF FIRE

The size and nature of the target determine how the automatic rifleman applies his fire. He must manipulate the M249 AR to move the beaten zone throughout the target area. The rate of fire must be controlled to adequately cover the target but not waste ammunition or destroy the barrel.

a. Distributed fire is delivered in width and depth such as at an enemy formation.

b. Concentrated fire is delivered at a point target such as an automatic weapon or an enemy fighting position.

c. The rates of fire that can be used with the M249 AR are sustained, rapid, and cyclic. These rates enable leaders to control and sustain fire and prevent the destruction of barrels. More than anything else, the size of the target and ammunition supply dictate the selection of the rate of fire.

(1) Sustained fire for the M249 automatic rifleman is 85 rounds per minute in bursts of 3 rounds. This allows the automatic rifle to be fired indefinitely without damage to the barrel from overheating. This is the normal rate of fire for the automatic rifleman.

(2) Rapid fire for the M249 automatic rifleman is 200 rounds per minute in bursts of 3 rounds. This provides for an exceptionally high volume of fire—but for only a short period.

(3) Cyclic fire uses the most ammunition that can be used in one minute. The cyclic rate of fire with the M249 AR is achieved when the trigger is held to the rear and ammunition is fed into the weapon uninterrupted for one minute. Normal cyclic rate of fire is 850 rounds.

6-5. TARGET ENGAGEMENT

The automatic rifleman engages targets throughout his sector on his own under the direct control of a leader. He must know how to effectively engage all types of targets either by himself or in conjunction with another automatic rifleman.

a. Single Automatic Rifleman.

(1) *Point target.* When engaging a point target, the automatic rifleman uses fixed fire (Figure 6-10). If the target moves after the initial burst, the automatic rifleman adjusts fire onto the target by following its movement.

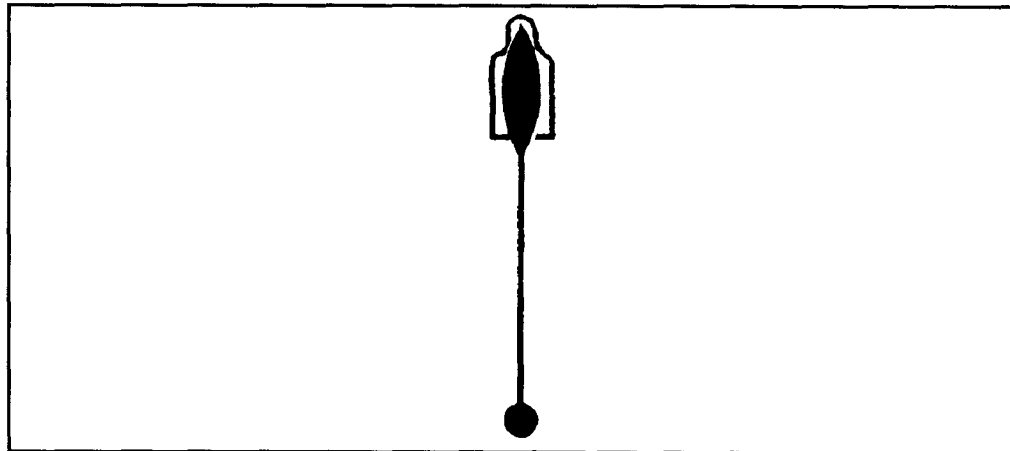

Figure 6-10. Engagement of point target.

(2) *Area target.* When engaging an area target, an automatic rifleman fires in the center of mass, then traverses and searches to either flank (Figure 6-11). Upon reaching the flank, he reverses direction and traverses and searches in the opposite direction. A leader may indicate the width and depth of the target.

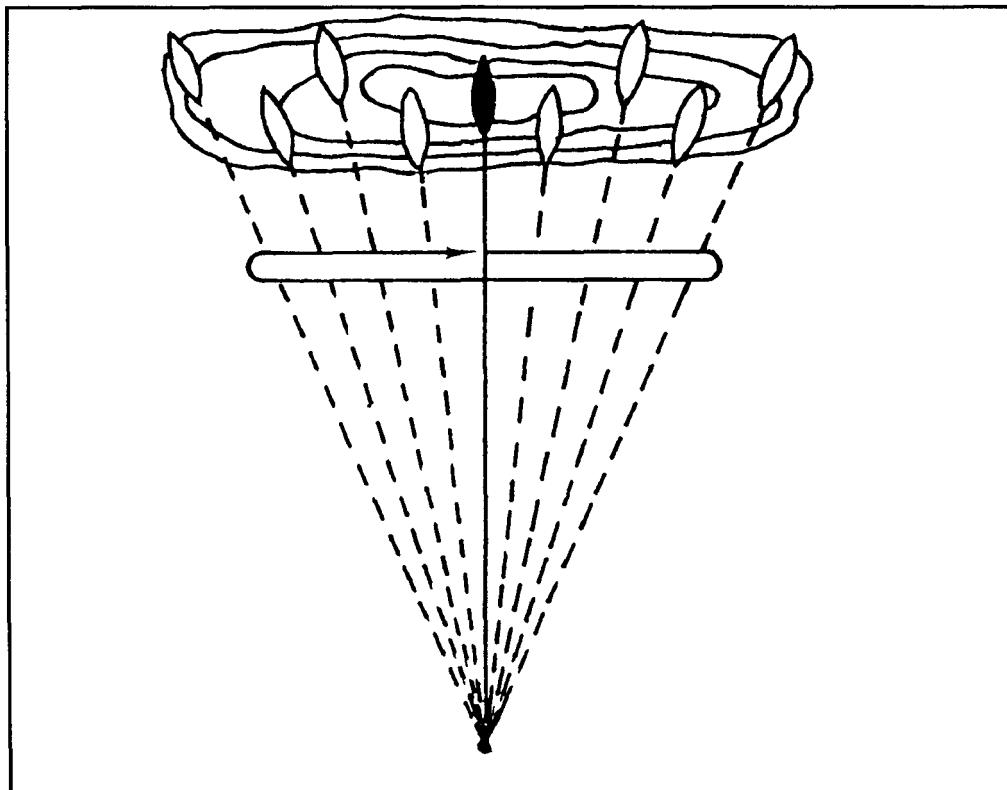

Figure 6-11. Engagement of area target.

(3) *Linear target.* When engaging a linear target, the automatic rifleman traverses the weapon to distribute fire evenly onto the target. He must cover the entire width of a linear target. The initial point of aim is on the midpoint. The automatic rifleman then manipulates to cover the rest of the target. If a linear target is hard to identify, a leader may designate the target by using a reference point (Figure 6-12, page 6-10). When this method is used, the leader determines the center of mass of the target and announces the number of meters from the reference point that will cause the automatic rifleman to aim on the center of mass. The reference point maybe within or adjacent to the target (Figure 6-13, page 6-10); however, it should be on line with the target for best effect. After the command to fire has been given, the leader maintains and controls the fire by subsequent fire commands.



Figure 6-12. Engagement of hard-to-identify targets with a reference point within the target area.



Figure 6-13. Engagement of hard-to-identify targets with a reference point within the target area.

(4) *Deep target.* When engaging a deep target, the automatic rifleman must use searching fire. If the range is announced, he initially aims on the midpoint of a deep target unless another portion of the target is more critical or presents a greater threat. The automatic rifleman then searches down to one aiming point in front of the near end and back up to one aiming point beyond the far end. If a deep target is hard to identify, its center of mass may be designated by using reference points. The extent (depth) of the target is always given in meters.

(5) *Linear target with depth.* When engaging a linear target with depth, the automatic rifleman uses traversing and searching fire. He begins engagement at the midpoint of the target unless another portion of the target is more critical or presents a greater threat. He traverses and searches to the near flank, then back to the far flank. When engaging hard-to-identify linear targets with depth, he designates the flanks and midpoint with rifle fire. The reference-point method is not used because at least two reference points are required to show the angle of the target.

b. Pair of Automatic Riflemen.

(1) *Area Targets.* When using pairs of M249s to engage area targets, the automatic rifleman on the right fires on the right half, and the automatic rifleman on the left fires on the left half. The point of initial aim and adjustment for both automatic riflemen is on the midpoint. After adjusting fire on the center of mass, both automatic riflemen distribute fire by applying direction and elevation changes that give the most effective coverage of the target area. The right automatic rifleman traverses to the right, applies the necessary amount of search, and fires a burst. He traverses and searches up and down until the right flank of the area target has been reached. The left automatic rifleman traverses and searches to the left flank in the same way. Both automatic riflemen then reverse the direction of manipulation and return to the center of mass, firing a burst after each combined direction and elevation change (Figure 6-14).

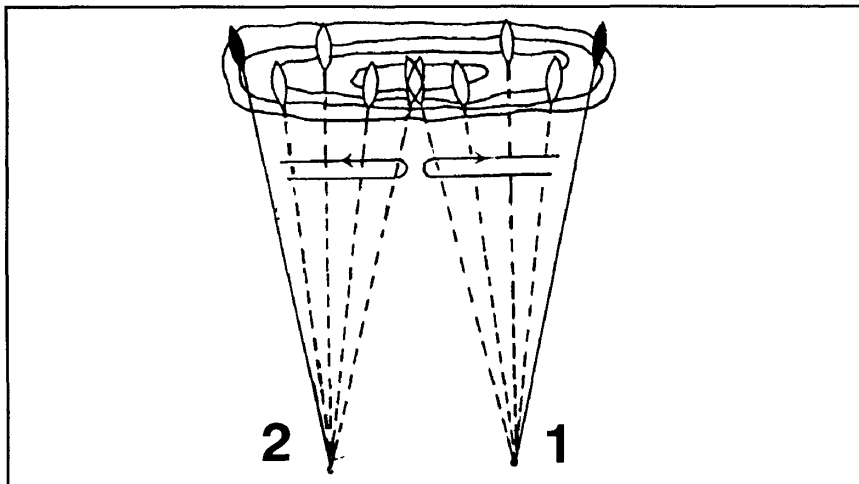

Figure 6-14. Engagement of area targets with a pair of automatic riflemen.

(2) *Linear Target*. When using a pair of M249s to engage a linear target, the target is divided at midpoint with the automatic rifleman on the right of the target firing on the right half, and the automatic rifleman on the left of the target firing on the left half (Figure 6-15).

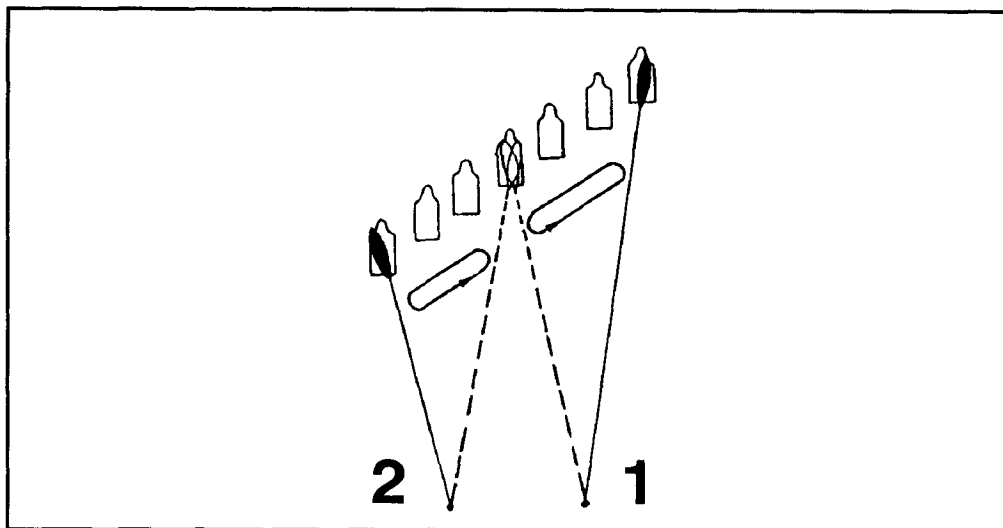

Figure 6-15. Engagement of linear targets with a pair of automatic riflemen.

(a) Both automatic riflemen aim on the midpoint initially. After adjusting on the midpoint, the automatic rifleman on the right traverses right, firing a burst after each change in direction until the rounds reach one aiming point beyond the right flank (this ensures complete target coverage). The automatic rifleman on the left traverses to the left flank in the same way. Both automatic riflemen then reverse their directions and return to the midpoint. the automatic rifleman must select aiming points for each burst rather than “spray” the target area.

(b) If one part of the target is a greater threat, fire can be concentrated on the greater threat by dividing the target unevenly. This special division of the target is done with fire commands. To preclude confusion, the automatic riflemen initially aim on the midpoint regardless of the special division to be made.

(3) *Deep Targets*. When using a pair of M249s to engage a deep target, the initial point of aim is also on the midpoint for both automatic riflemen. Normally, the automatic rifleman on the right has the near half and the automatic rifleman on the left has the far half. Since enfilade fire is being used, they do not adjust on the midpoint of the target, because the long beaten zone compensates for any range errors. After the initial burst, the

automatic rifleman on the right searches down to one aiming point in front of the near end of the target, and the automatic rifleman on the left searches up to one aiming point beyond the far end. Both automatic riflemen then reverse their direction of search and return to the midpoint (Figure 6-16).



Figure 6-16. Engagement of deep targets with a pair of automatic riflemen.

(4) *Linear Target with Depth.* When using a pair of M249s to engage a linear target with depth, the initial point of aim and the extent of manipulation for both automatic riflemen is the same as those prescribed for linear targets (Figure 6-17).

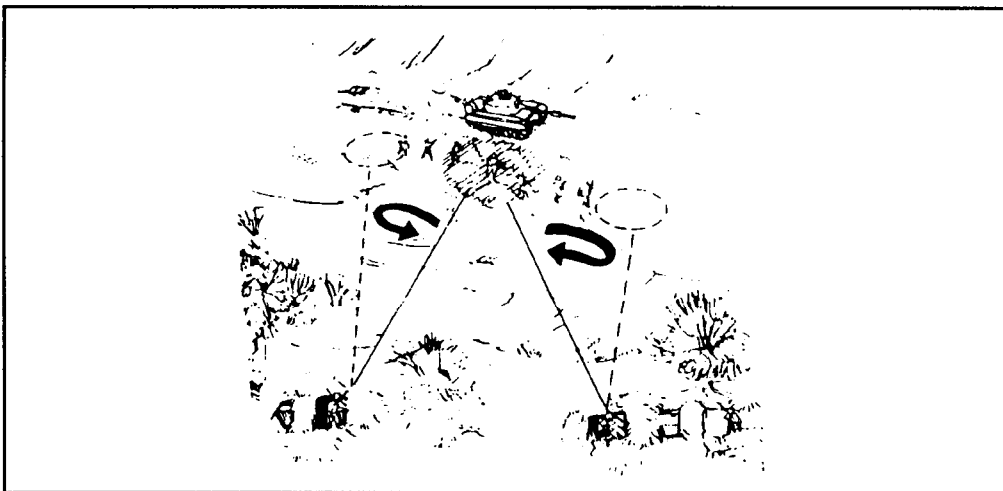

Figure 6-17. Engagement of linear target with depth with a pair of automatic riflemen.

6-6. TARGET ENGAGEMENT DURING LIMITED VISIBILITY

Automatic riflemen have problems detecting and identifying targets during limited visibility. The leader's ability to control the fires of his weapons is also reduced. Therefore, he may instruct the automatic riflemen to fire without command when targets present themselves.

a. Automatic riflemen should engage targets only when they can identify the targets, unless ordered to do otherwise. For example, if one automatic rifleman detects a target and engages it, the other automatic riflemen observe the area fired upon and adds his fire only if he can identify the target or if ordered to fire.

b. Tracer ammunition helps an automatic rifleman engage targets during limited visibility and should be used, if possible. If firing unaided, automatic riflemen must be trained to fire low at first and adjust upward. This overcomes the tendency to fire high.

c. When two or more automatic riflemen are engaging linear targets, linear targets with depth, or deep targets, they do not engage these targets as they would when visibility is good. With limited visibility, the center and flanks of these targets may not be clearly defined; therefore, each automatic rifleman observes his tracers and covers what he believes to be the entire target.

Section III. PREDETERMINED FIRES

Predetermined fires organize the battlefield for the automatic riflemen. They allow the leader and automatic riflemen to select potential targets or target areas that will most likely be engaged or that have tactical significance. This includes dismounted enemy avenues of approach, likely positions for automatic weapons, and probable enemy assault positions. The automatic riflemen do this by using sectors of fire, final protective lines, or a principal direction of fire and selected target areas. This preparation maximizes the effectiveness of the automatic rifle during good as well as limited visibility. It enhances fire control by reducing the time required to identify targets, determine range, and manipulate the weapon onto the target. Abbreviated fire commands and previously recorded data enable the automatic rifleman to aim or adjust fire on the target quickly and accurately. Selected targets should be fired on in daylight whenever practical to confirm data. The range card identifies the targets and provides a record of firing data.

6-7. TERMINOLOGY

Several terms are associated with predetermined fire that every automatic rifleman needs to know.

a. **Sector of Fire.** A sector of fire is an area to be covered by fire that is assigned to an individual, a weapon, or a unit. Automatic riflemen are normally assigned a primary and a secondary sector of fire.

b. **Final Protective Fire.** An FPF is an immediately available prearranged barrier of fire to stop enemy movement across defensive lines or areas.

c. **Final Protective Line.** An FPL is a predetermined line along which grazing fire is placed to stop an enemy assault. If an FPL is assigned, the M249 is sighted along it except when other targets are being engaged. An FPL becomes the M249's part of the unit's final protective fires. An FPL is fixed in direction and elevation; however, a small shift for search must be employed to prevent the enemy from crawling under the FPL and to compensate for irregularities in the terrain or the sinking of the bipod legs into soft soil during firing. Fire must be delivered during all conditions of visibility.

d. **Principal Direction of Fire.** A PDF is a direction of fire assigned priority to cover an area that has good fields of fire or has a likely dismounted avenue of approach. It also provides mutual support to an adjacent unit. Weapons are sighted using the PDF if an FPL has not been assigned. If a PDF is assigned and other targets are not being engaged, weapons remain on the PDF. A PDF has the following characteristics.

(1) It is used only if an FPL is not assigned; it then becomes the M249's part of the unit's final protective fires.

(2) When the target has width, direction is determined by aiming on one edge of the target area and noting the amount of traverse necessary to cover the entire target.

(3) The automatic rifleman is responsible for the entire wedge-shaped area from the muzzle of the weapon to the target, but elevation maybe fixed for a priority portion of the target.

e. **Grazing Fire.** A good FPL covers the maximum area with grazing fire. Grazing fire can be obtained over various types of terrain out to a maximum of 600 meters. To obtain the maximum extent of grazing fire over level or uniformly sloping terrain, the automatic rifleman sets the rear sight at 600 meters. He then selects a point on the ground that he estimates to be 600 meters from the weapon, and he aims, fires, and adjusts on that point. To prevent enemy soldiers from crawling under grazing fire, he searches (downward) by lowering the muzzle of the weapon. To do this, the automatic rifleman separates his elbows.

f. **Dead Space.** The extent of grazing fire and the extent of dead space may be determined in two ways. In the preferred method, the weapon is adjusted for elevation and direction. A member of the squad then walks along the FPL while the automatic rifleman aims through the sights. In places where the soldier's waist (midsection) falls below the automatic

rifleman's point of aim, dead space exists. Arm-and-hand signals must be used to control the soldier who is walking and to obtain an accurate account of the dead space and its location. Another method is to observe the flight of tracer ammunition from a position behind and to the flank of the weapon.

g. **Fire Control.** Predetermined targets, including the FPL or PDF, are engaged on order or by SOP. The signal for calling for these fires is normally stated in the defense order. Fires on predetermined targets may be controlled by arm-and-hand signals, voice commands, or pyrotechnic devices. Automatic riflemen fire the FPL or PDF at the sustained rate of fire unless the situation calls for a higher rate. When engaging other predetermined targets, the sustained rate of fire is also used unless a different rate is ordered.

h. **Primary Sector of Fire.** The primary sector of fire is the area to be covered by an individual or unit.

i. **Secondary Sector of Fire.** The secondary sector of fire is the same area covered by the same individual or unit after it has moved to a different location.

6-8. RANGE CARD

The standard range card (DA Form 5517-R) provides a record of firing data and aids defensive fire planning. (See FM 7-8 for a reproducible copy of this form.) Its use enhances fire control and rapid engagement of predetermined targets. It is also used in estimating ranges to other targets within the sector of fire. Each automatic rifleman makes two copies—one for his position and one for the squad leader. The squad leader uses his copy to prepare his sector sketch. The range card is prepared immediately upon occupation and is constantly revised. Each range card contains the following:

- Weapon symbol. (Figure 6-18.)
- Sector of fire.
- PDF or FPL.
- Range, azimuth, and number label to predetermined targets.
- Dead space.
- Distance and azimuth from a known point or eight-digit grid coordinate (automatic rifle reference point).
- Magnetic north arrow.
- Data section.

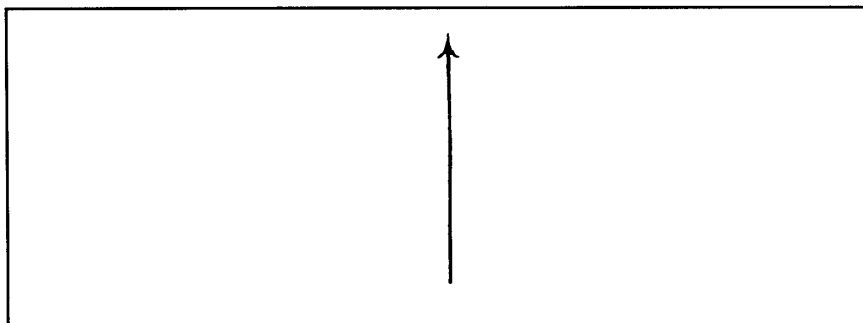

Figure 6-18. Automatic weapon symbol.

a. **Procedures.** The M249 AR is placed in the bipod-supported mode in the position it will be fired. The machine gun symbol is sketched on the range card pointing toward the most dangerous target in the sector.

(1) If using an FPL, the automatic rifleman aims the weapon along the FPL. This will also be either the left or right limit of the sector of fire. To set the limit, he emplaces a stake behind the foot of the bipod leg and another stake on the outside of the buttstock. Then, he adjusts the weapon to aim along the opposite limit. A stake is emplaced behind the foot of the other bipod leg and another stake is emplaced on the outside of the buttstock to set the limit. The sector of fire with an FPL along one limit is now prepared.

(2) If an FPL is not assigned, the left and right limits are set with stakes in the same manner. Then, the weapon is adjusted to aim along the PDF. Markers or stakes are placed immediately to the left and right of the feet of the bipod legs. When firing along the PDF, the automatic rifleman aligns the bipod feet with the markers.

(3) To determine the range for all targets in the sector, the automatic rifleman ensures each circle, except the first one, represents 100 meters. Since the lowest setting on the M249 AR is 300 meters, the first circle represents 300 meters. He indicates this on the range card in the data section just below the circles. On the top half of the range card, the automatic rifleman draws the left or right limits from the weapon position to the maximum effective range of the M249 AR.

(4) If an FPL is assigned, the automatic weapon symbol is drawn along that line (left or right limit) (Figure 6-19, page 6-19).

(5) The extent of grazing fire is determined. A shaded blade is sketched on the inside of the FPL to represent the extent of the grazing fire.

(6) If there is dead space along the FPL, it is shown by breaks in the shaded area.

(7) The ranges to the near and far edges of the dead space are recorded above the FPL, and the extent of the grazing fire is recorded along the FPL.

(8) The magnetic azimuth of the FPL is determined and recorded below the shaded blade representing the FPL.

(9) If a PDF is assigned, the automatic weapon symbol is sketched in the center of the left and right limits pointing in the direction of the PDF (Figure 6-20, page 6-20).

(10) Next, the left and right limits of the secondary sector are drawn using a broken line. The area between the primary and secondary sector is labeled dead space.

(11) An arrow is drawn in the magnetic north block (upper right hand corner) pointing in the direction of magnetic north.

(12) The position is oriented with a prominent terrain feature (recognizable on a map) by obtaining a magnetic azimuth to or from the terrain feature to the position.

(13) A line is drawn between these two points. Arrow barbs are drawn along this line pointing in the direction the magnetic azimuth was taken. The magnetic azimuth is recorded in degrees below the line.

(14) If a prominent terrain feature is not available, the position is identified by using an eight-digit grid coordinate. The grid coordinate is recorded below the position on the range card.

(15) The automatic rifleman's number, unit designation (sqd, pit, CO), and date are recorded in the upper left hand corner. For security, a unit designation higher than a company is not used.

(16) Targets within the sector are identified. A symbol is drawn to represent the target in the appropriate place within the sector of fire. Targets in the primary sector are shown by numbers enclosed in circles. An FPL, when assigned, is always labeled target number 1. Other targets are assigned subsequent numbers in order of tactical importance.

(17) The ranges to the targets are determined and recorded below each target sketch.

(18) For targets in the secondary sector, the target is sketched on the range card, the range determined, and recorded below the sketch.

(19) The target number, direction, range, and description are recorded in the data section for targets in the primary sector but not for the secondary sector.

(20) For targets in both the primary and secondary sector, the field expedients used to engage targets are drawn above the sketch of the target.

STANDARD RANGE CARD
For use of this form see FM 7-8. The proponent agency is TRADOC.

SQD <u>2</u> PLT <u>1ST</u> CO <u>C</u>	May be used for all types of direct fire weapons.	 MAGNETIC NORTH
---	---	---

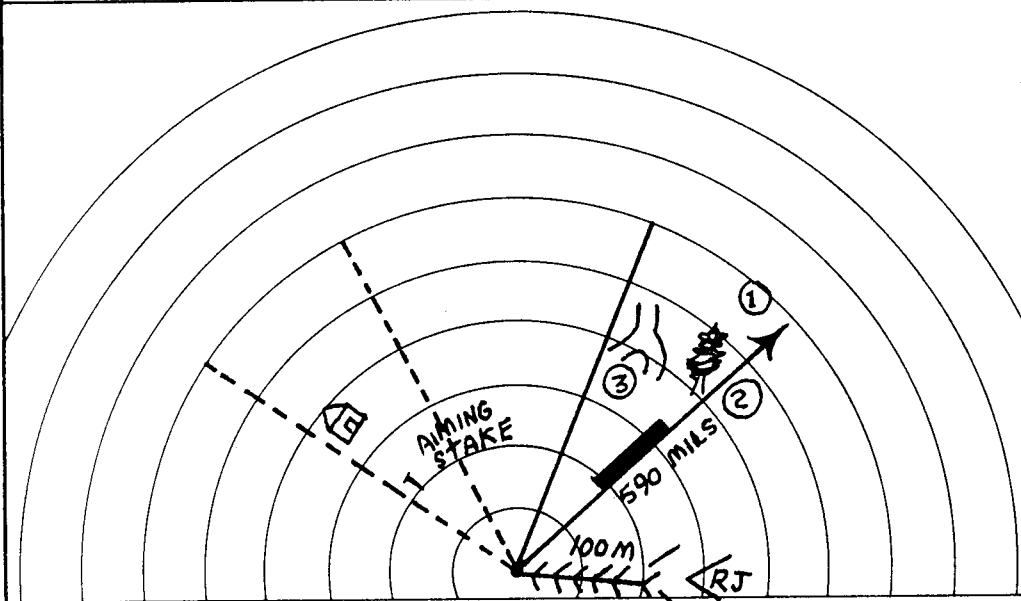

DATA SECTION

POSITION IDENTIFICATION		DATE <u>25 JUN. 93</u>			
WEAPON <u>M249</u>		EACH CIRCLE EQUALS <u>100 m</u> METERS			
NO.	DIRECTION/ DEFLECTION	ELEVATION	RANGE	AMMO	DESCRIPTION
1	/				FPL
2	350°		600		LONE TREE
3	300°		605		TRAIL JUNCTION
REMARKS:					

DA FORM 5517-R, FEB 86

Figure 6-19. Final protective line.

STANDARD RANGE CARD
For use of this form see FM 7-8. The proponent agency is TRADOC.

SQD 2d
PLT 2d
CO C

May be used for all types of direct fire weapons.

MAGNETIC NORTH 

RANGE CARD WITH A PDF

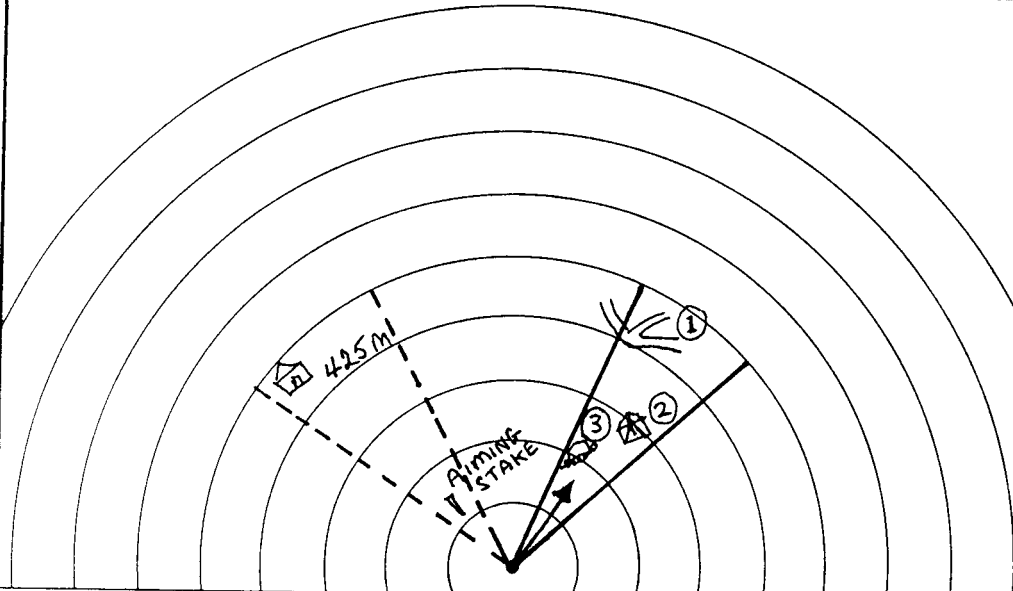

DATA SECTION

POSITION IDENTIFICATION _____ DATE 25 JUN 93

WEAPON M249 #2 EACH CIRCLE EQUALS 100 M METERS

NO.	DIRECTION/DEFLECTION	ELEVATION	RANGE	AMMO	DESCRIPTION
1	25°	N/A	600		PDF (ROAD JUNCTION)
2	60°	N/A	500		BARN
3	29°	N/A	400		HEDGE ROW

REMARKS:

DA FORM 5517-R, FEB 86

Figure 6-20. Principal direction of fire.

b. **Field Expedient.** When laying the M249 AR for predetermined targets, the automatic rifleman can use field expedients as a means of engaging targets when other sources are not available.

(1) The automatic rifleman uses the notched-stake or tree-crotch technique (Figure 6-21) to engage predetermined targets within a sector or to define sector limits. This method is effective during all conditions of visibility, and it requires little additional material.

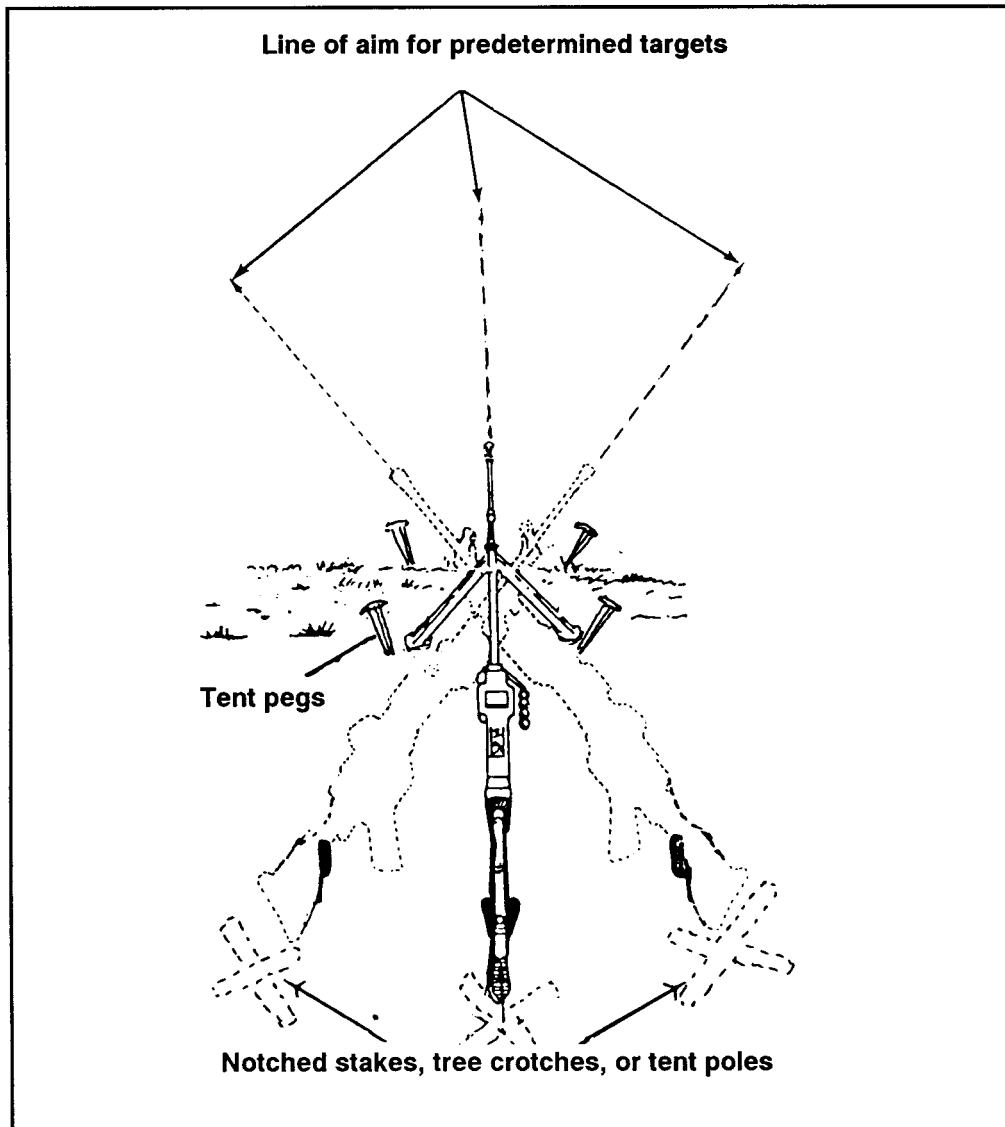

Figure 6-21. Notched-stake or tree-crotch technique of engaging predetermined targets.

(2) The automatic rifleman first drives either a notched stake or tree crotch into the ground where selected targets are anticipated. He then places the stock of the M249 in the nest of the stake or crotch and adjusts the weapon to hit the selected targets and to define his sector limits.

NOTE: If notched stakes and crotches are not available, tent poles can be used. It requires four poles for the left and right limits and additional poles for target areas. The automatic rifleman drives two poles in the ground in the shape of an X and then places the stock within that X as described with stakes and crotches.

(3) To better control the weapon within his sector, he drives tent pegs in the ground in front and behind the feet of the bipod legs where he can rotate the weapon from left to right or vice versa (Figure 6-21).

Section IV. FIRE CONTROL

Fire control includes all actions of the leader and soldiers in planning, preparing, and applying fire on a target. The leader selects and designates targets. He also designates the midpoint and flanks or ends of a target, unless they are obvious to the automatic rifleman. It is the automatic rifleman's responsibility to open fire at the instant desired, and then to adjust fire, regulate the rate of fire, shift from one target to another, and cease fire. When firing, the automatic rifleman should continue to fire until the target is neutralized or until signaled to do otherwise by the leader.

6-9. METHODS OF FIRE CONTROL

The noise and confusion of battle may limit the use of some of these methods; therefore, the leader must select a method or combination of methods that will accomplish the mission.

a. **Oral.** This can be an effective method of control, but sometimes the leader may be too far away from the automatic rifleman, or the noise of the battle may make it impossible for him to hear. The primary means of the oral fire control method is the issuance of a fire command.

b. **Arm-and-Hand Signals.** This is an effective method when the automatic rifleman can see the leader. All automatic riflemen must know the standard arm-and-hand signals. The leader gets the automatic rifleman's attention and then points to the target. When the automatic rifleman returns the READY signal, the leader commands FIRE.

c. **Prearranged Signals.** These are either visual or sound signals such as casualty-producing devices, pyrotechnics, whistle blasts, or tracers. These signals should be included in SOPs. If the leader wants to shift fire at a certain

time, he gives a prearranged signal such as smoke or pyrotechnics. Upon seeing the signal, the automatic rifleman shifts his fire to a prearranged point.

d. **Personal Contact.** In many situations, the leader must issue orders directly to individual soldiers. This method is used more than any other by small-unit leaders. The leader must use maximum cover and concealment to keep from disclosing the position or himself.

e. **Standing Operating Procedures.** SOPs are actions to be executed without command that are developed during the training of the squads. Their use eliminates many commands and simplifies the leader's fire control. SOPs for certain actions and commands can be developed to make automatic riflemen more effective. Some examples follow.

(1) *Observation.* The automatic riflemen continuously observe their sectors.

(2) *Fire.* Automatic riflemen open fire without command on appropriate targets that appear within their sectors.

(3) *Check.* While firing, the automatic riflemen periodically check with the leader for instructions.

(4) *Return Fire.* The automatic riflemen return enemy fire without order, concentrating on enemy automatic weapons.

(5) *Shift Fire.* Automatic riflemen shift their fires without command when more dangerous targets appear.

(6) *Rate of Fire.* When automatic riflemen engage a target, they initially fire at the rate necessary to gain and maintain fire superiority.

(7) *Mutual Support.* When two or more automatic riflemen are engaging the same target and one stops firing, the other increases the rate of fire and covers the entire target. When only one automatic rifleman is required to engage a target and the leader has alerted two or more, the automatic rifleman not firing aims on the target and follows the movements of the target so that he can fire instantly should the other M249 AR malfunction or cease fire before the target has been eliminated.

f. **Range Cards.** When using this method of fire control, the leader must ensure all range cards are current and accurate. Once this is done, the leader may designate certain targets for certain weapons with the use of limiting stakes or with fire commands. He should also designate no-fire zones or restricted fire areas to others. The key factor in this method of fire control is that automatic riflemen must be well disciplined and pay attention to detail.

6-10. FIRE COMMANDS

A fire command is given to deliver effective fire on a target quickly and without confusion. When the leader decides to engage a target that is not obvious to the squad, he must provide them with the information they need to effectively engage the target. He must alert the soldiers; give a target direction, description, and range; name the method of fire; and give the command to fire. There are initial fire commands and subsequent fire commands.

a. **Initial Fire Commands.** Initial fire commands are given to adjust onto the target, change the rate of fire after a fire mission is in progress, interrupt fire, or terminate the alert.

b. **Elements.** Fire commands for all direct-fire weapons follow a pattern that includes similar elements. There are six elements in the fire command for the M249 AR: alert, direction, description, range, method of fire, and command to open fire. The automatic riflemen repeat each element of fire command as it is given.

(1) *Alert.* This element prepares the automatic riflemen for further instructions. The leader may alert both automatic riflemen in the squad and may have only one fire, depending upon the situation. To alert and have both automatic riflemen fire, the leader announces "Automatic riflemen." If he desires to alert both automatic riflemen but have only one fire, he announces "Automatic rifleman, Alpha Team." In all cases, upon receiving the alert, the automatic riflemen load their M249 ARs and place them on FIRE.

(2) *Direction.* This element indicates the general direction to the target and may be given in one or a combination of the following methods.

(a) *Orally.* The leader orally gives the direction to the target in relation to the position of the automatic rifleman (for example, FRONT, LEFT FRONT, RIGHT FRONT).

(b) *Pointing.* The leader designates a small or obscure target by pointing with his finger or aiming with a weapon. When he points with his finger, a soldier standing behind him should be able to look over his shoulder and sight along his arm and index finger to locate the target. When aiming his weapon at a target, a soldier looking through the sights should be able to see the target.

(c) *Tracer ammunition.* Tracer ammunition is a quick and sure method of designating a target that is not clearly visible. When using this method, the leader should first give the general direction in order to direct the automatic rifleman's attention to the target area. To prevent the loss of surprise when using tracer ammunition, the leader does not fire until he has given all elements of the fire command except the command to fire. The leader may fire his individual weapon or fire one or more bursts from a machine gun.

The firing of the tracer(s) then becomes the last element of the fire command and is the signal to open fire.

NOTE: Soldiers must be aware that with the night vision device, “white out” may occur when firing tracer ammunition at night or when exposed to other external light sources. Lens covers may reduce this effect.

Example:

AUTOMATIC RIFLEMAN
FRONT
FIVE HUNDRED
WATCH MY TRACER(S)

(d) Reference points. Another way to designate obscure targets is to use easy-to-recognize reference points. All leaders and automatic riflemen must know terrain features and the terminology used to describe them (FM 21-26). When using a reference point, the word “reference” precedes its description. This is done to avoid confusion. The general direction to the reference point should be given.

Example:

AUTOMATIC RIFLEMAN
FRONT
REFERENCE: BUNKER, CENTER MASS
TARGET: TROOPS EXTENDING SHORT ONE HUNDRED,
OVER
ONE HUNDRED
FOUR HUNDRED
FIRE

(Sometimes the reference point may be outside the target area).

Example:

AUTOMATIC RIFLEMAN
FRONT
REFERENCE: BUNKER, RIGHT FOUR FINGERS, CENTER
MASS
TARGET: TROOPS EXTENDING SHORT ONE HUNDRED,
OVER
ONE HUNDRED
THREE HUNDRED

SEARCH
AT MY COMMAND
FIRE

(Sometimes a target must be designated by using successive reference points).

Example:

AUTOMATIC RIFLEMAN, ALPHA TEAM
RIGHT FRONT
REFERENCE: RED-ROOFED HOUSE, LEFT TO HAYSTACK,
LEFT
TO BARN

(Finger measurements can be used to direct the automatic rifleman's attention to the right or left of reference points).

Example:

AUTOMATIC RIFLEMAN
LEFT FRONT
REFERENCE: CROSSROADS, RIGHT FOUR FINGERS

(3) *Description.* The target description creates a picture of the target in the minds of the automatic riflemen. To properly apply their fire, the soldiers must know the type of target they are to engage. The leader should describe it briefly. If the target is obvious, no description is necessary.

(4) *Range.* The leader always announces the estimated range to the target. The range is given so the automatic rifleman knows how far to look for the target and what range setting to put on the rear sight. Range is announced in meters; however, since the meter is the standard unit of range measurement, the word "meters" is not used. With M249 ARs, the range is determined and announced to the nearest hundred or thousand (in other words, THREE HUNDRED, or ONE THOUSAND).

Example:

AUTOMATIC RIFLEMAN
FRONT
REFERENCE: KNOCKED-OUT TANK, LEFT TWO FINGERS
TARGET: TROOPS
THREE HUNDRED

(5) *Method of fire.* This element includes manipulation and rate of fire. Manipulation is used to prescribe the class of fire with respect to the weapon. It is announced as FIXED, TRAVERSE, SEARCH, or TRAVERSE AND

SEARCH. Rate is used to control the volume of fire (sustained, rapid, and cyclic). Normally, the automatic rifleman uses the sustained rate of fire. The rate of fire is omitted from the fire command. The method of fire for the M249 in the AR mode is a three-round burst. For area targets beyond 400 meters, a five- to seven-round burst maybe needed to create an effective beaten zone.

Example:

AUTOMATIC RIFLEMAN

FRONT

REFERENCE: KNOCKED-OUT TANK, LEFT TWO FINGERS

TARGET: TROOPS

THREE HUNDRED

TRAVERSE

(6) *Command to open fire.* It is recommended that fire be withheld so that surprise fire can be delivered on a target or to ensure that both automatic riflemen open fire at the same time. The leader may preface the command to commence firing with AT MY COMMAND or AT MY SIGNAL. When the automatic riflemen are ready to engage the target, they report READY to the leader. The leader then gives the command FIRE at the specific time desired.

Example:

AUTOMATIC RIFLEMAN

FRONT

TROOPS

FOUR HUNDRED

AT MY COMMAND or AT MY SIGNAL (Pause until automatic riflemen are ready and fire is desired.)

FIRE (on prearranged signal)

If immediate fire is required, the command FIRE is given without pause and the automatic riflemen fire as soon as they are ready.

c. **Subsequent Fire Commands.** These fire commands are used to make adjustments in direction and elevation, to change rates of fire after a fire mission is in progress, to interrupt fires, or to terminate the alert. If the automatic rifleman fails to properly engage a target, the leader must promptly correct him by announcing or signaling the desired changes. When these changes are given, the automatic rifleman makes the corrections and resumes firing without further command.

(1) Adjustments in direction and elevation with the M249 AR are always given in meters; one finger is used to indicate 1 meter and so on. Adjustment for direction is given first. For example: RIGHT ONE ZERO METERS or LEFT FIVE METERS. Adjustment for elevation is given next. For example: ADD FIVE METERS or DROP ONE FIVE METERS. These changes may be given orally or with arm-and-hand signals.

(2) Changes in the rate of fire are given orally or by arm-and-hand signals.

(3) To interrupt firing, the leader announces "Cease fire," or he signals to cease fire. The automatic riflemen remain on the alert. They resume firing when given the command FIRE.

(4) To terminate the alert, the leader announces "Ceasefire, end of mission."

d. Doubtful Elements and Corrections. When the automatic rifleman is in doubt about any element of the fire command, he replies "Say again range, target." The leader then announces "The command was," repeats the element in question, and continues with the fire command.

(1) When the leader makes an error in the initial fire command, he corrects it by announcing "Correction," and then gives the corrected element.

Example:

AUTOMATIC RIFLEMAN
FRONT
TROOPS
SIX HUNDRED
CORRECTION
THREE HUNDRED
TRAVERSE
AT MY COMMAND

(2) When the leader makes an error in the subsequent fire command, he may correct it by announcing "Correction," and then repeating the entire subsequent fire command.

Example:

LEFT FIVE METERS, DROP ONE METER
CORRECTION
LEFT FIVE METERS, DROP ONE HUNDRED METERS

e. Abbreviated Fire Commands. Fire commands need not be complete to be effective. In combat, the leader gives only the elements necessary to

place fire on a target quickly and without confusion. During training, however, he should use all of the elements to get automatic riflemen in the habit of thinking and reacting properly when a target is to be engaged. After the automatic rifleman's initial training in fire commands, he should be taught to react to abbreviated fire commands, using one of the following methods.

(1) *Oral*. The leader may want to place the fire of one M249 AR on an enemy machine gun.

Example:

AUTOMATIC RIFLEMAN, ALPHA TEAM
MACHINE GUN
FOUR HUNDRED
FIRE

(2) *Arm-and-hand signals*. Battlefield noise and the distance between the automatic rifleman and the leader often make it necessary to use arm-and-hand signals to control fire (Figure 6-22, page 6-30). When an action or movement is to be executed by only one of the automatic riflemen, a preliminary signal is given to that automatic rifleman only. The following are commonly used signals for fire control.

(a) *Ready*. The automatic rifleman indicates that he is ready to fire by yelling "Up" or having another soldier nearby raise his hand or arm above his head toward the leader.

(b) *Commence firing or change rate of firing*. The leader brings his hand (palm down) to the front of his body about waist level, and moves it horizontally in front of his body. To signal an increase in the rate of fire, he increases the speed of the hand movement; to signal slower fire, he decreases the speed of the hand movement.

(c) *Change direction or elevation*. The leader extends his arm and hand in the new direction and indicates the amount of change necessary by the number of fingers extended. The fingers must be spread so the automatic rifleman can easily see the number of fingers extended. Each finger indicates 1 meter of change for the weapon. If the desired change is more than 5 meters, the leader extends his hand the number of times necessary to indicate the total amount of change. For example, RIGHT NINE would be indicated by extending the hand once with five fingers showing and a second time with four fingers showing for a total of nine fingers.

(d) *Interrupt or cease firing*. The leader raises his arm and hand (palm outward) in front of his forehead and brings it downward sharply.

(e) *Other signals*. The leader can devise other signals to control his weapons. A detailed description of arm-and-hand signals is given in FM 21-60.

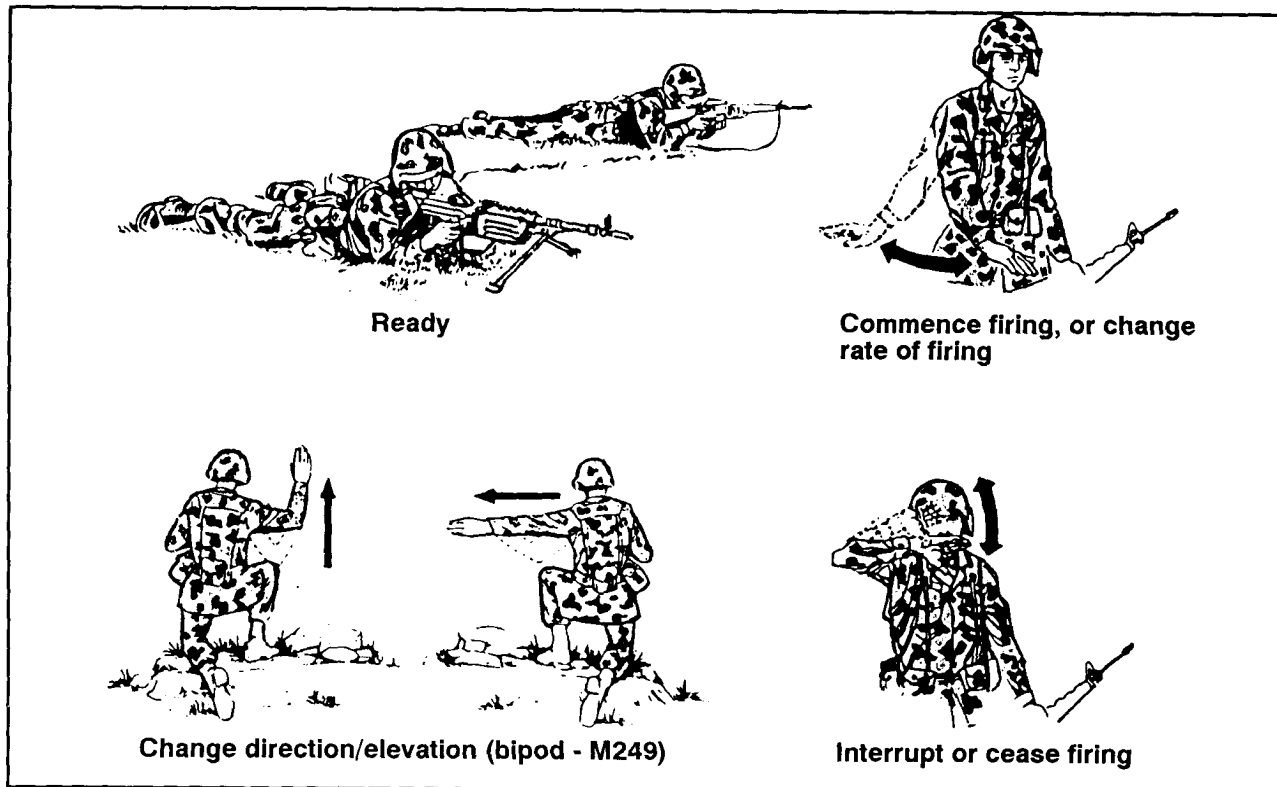

Figure 6-22. Arm-and-hand signals.

Section V. RANGE DETERMINATION

During combat, ranges are seldom known. Poor visibility and damp ground often make adjustment of fire by observation difficult if not impossible. Therefore, correct range determination is extremely important for accurate effective fire. Range estimation and lateral distance measurement are two methods used to determine the range to the target.

6-11. RANGE ESTIMATION

Range estimation is determining the distance between two points. In most situations, one of these points is the automatic rifleman's own position; the other point may be a target or prominent terrain feature. **THE AUTOMATIC RIFLEMAN MUST ACCURATELY DETERMINE RANGE TO SET THE SIGHTS AND EFFECTIVELY FIRE ON A TARGET WITH THE FIRST BURST.**

a. Not only does the accurate estimation of range affect marksmanship, but it is also required in the reporting of information and the adjustment of artillery and mortar fire (Table 6-1).

FACTORS AFFECTING RANGE ESTIMATION	FACTORS CAUSING UNDERESTIMATION	FACTORS CAUSING OVERESTIMATION
The clearness of outline and details of the target.	When most of the target is visible and offers a clear outline.	When only a small portion of the target can be seen or the target is small in relation to its surroundings.
Nature of terrain or position of the observer.	When looking across a depression that is mostly hidden from view.	When looking across a depression that is totally visible.
	When looking downward from high ground.	When looking from low ground toward high ground.
	When looking down a straight, open road or along a railroad.	When vision is narrowly confined as in streets, draws, or forest trails.
	When looking over uniform surfaces like water, snow, desert, or grain fields.	
Light and atmosphere.	In bright light or when the sun is shining from behind the observer.	In poor light such as dawn and dusk; in rain, snow, fog; or when the sun is in the observer's eyes.
	When the target is in sharp contrast with the background or is silhouetted because of its size, shape, or color.	When target blends into the background or terrain.
	When seen in the clear air of high altitudes.	

Table 6-1. Factors of range estimation.

b. There are several methods of estimating range. They include measuring distance on a map, pacing the distance between two points, and using an optical range finder. However, the automatic rifleman does not usually have a map and rarely has access to an optical range finder. He can pace the distance between two points if the enemy is not within range. Firing rounds to determine the range is not desirable, since it may reveal the position to enemy. Most of the time, the automatic rifleman must use

techniques that do not require equipment and can be used without exposing himself or revealing his position. There are two methods that meet these requirements: the appearance-of-objects and the 100-meter-unit-of-measure.

(1) *Appearance-of-objects method.* This method is a means of estimating range by the size and other characteristic details of the object.

(a) This is a common method of determining distances and is used most often. For example, a motorist trying to pass another car must judge the distance of oncoming vehicles based on his knowledge of how vehicles appear at various distances. In this example, the motorist is not interested in precise distances but only in having enough road space to safely pass the car. Suppose, however, the motorist knew that at a distance of 1 kilometer, an oncoming vehicle appeared to be 1 centimeter between headlights. Then, anytime he saw other oncoming vehicles that fit these dimensions, he would know they were about 1 kilometer away. This same technique can be used by the automatic rifleman to estimate ranges on the battlefield. If the automatic rifleman knows the characteristic size and detail of men and equipment at known ranges, he can compare these characteristics to similar objects at unknown ranges. When characteristics match, so does the range.

(b) To use the appearance-of-objects method with any degree of accuracy, the automatic rifleman must know the characteristic details of objects as they appear at various ranges. For example, the automatic rifleman should study the appearance of a man standing at a range of 100 meters. He fixes the man's appearance firmly in his mind, carefully noting details of size and the characteristics of uniform and equipment. Next, he studies the same man in a kneeling position and then in a prone position. By comparing the appearance of the man at known ranges from 100 to 500 meters, the automatic rifleman can establish a series of mental images that will help determine range on unfamiliar terrain. Training should also be conducted in the appearance of other familiar objects such as weapons or vehicles. Because the successful use of this method depends upon visibility, anything that limits visibility (such as weather, smoke, or darkness) will also limit the effectiveness of this method.

(2) *100-meter-unit-of-measure method.* To use this method, the automatic rifleman visualizes a distance of 100 meters on the ground. For ranges up to 500 meters (Figure 6-23), he determines the number of 100-meter increments between the two points he wishes to measure. Beyond 500 meters (Figure 6-24), he selects a point halfway to the target, determines the number of 100-meter increments to the halfway point, and then doubles it to find the range to the target.

(a) During training, the automatic rifleman must become familiar with the effect that sloping terrain has on the appearance of a 100-meter increment. Terrain that slopes upward gives the illusion of longer distance, and observers have a tendency to overestimate the 100-meter increment. Terrain that slopes downward gives the illusion of shorter distance. In this case, the observer's tendency is to underestimate the 100-meter increment and thus underestimate the range.

(b) Proficiency in the 100-meter-unit-of-measure method requires constant practice. When training in this technique, the automatic rifleman should make frequent comparisons between the range as determined by the himself and by pacing or other accurate means of measurement. The best training technique is to pace the range after he has visually determined it. In this way, he discovers the actual range for himself, which makes a much greater impression than if he is told the correct range.

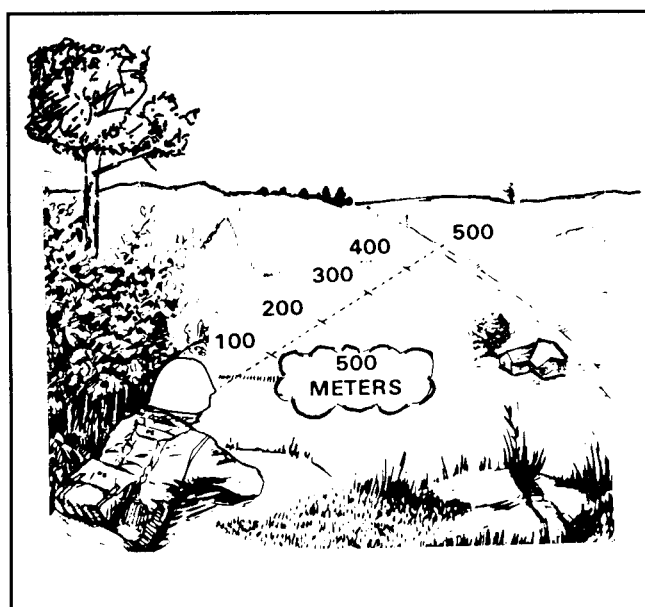

Figure 6-23. 100m to 500m unit-of-measure method.

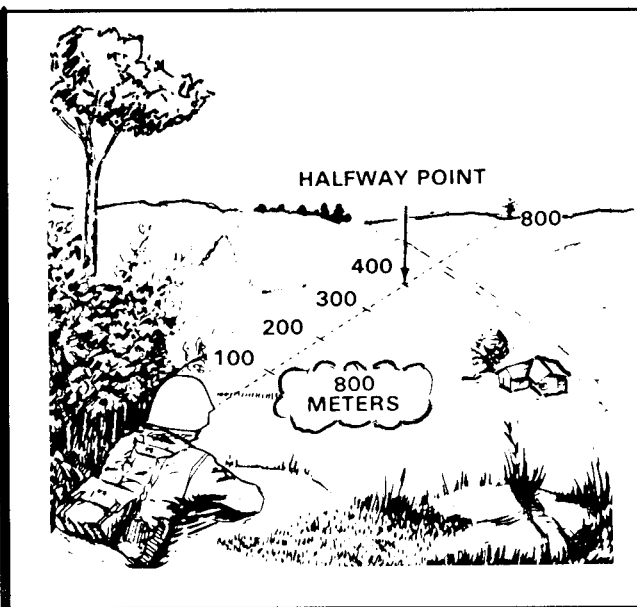

Figure 6-24. 100m to 800m unit-of-measure method.

(c) A limitation of the 100-meter-unit-of-measure method is that its accuracy is directly related to the amount of terrain visible to the observer. This is particularly true at greater ranges. If a target appears at a range of 500 meters or more and the automatic rifleman can only see a portion of the ground between himself and the target, it becomes difficult to use the 100-meter-unit-of-measure method of range estimation with any degree of accuracy.

(3) *Combination of methods.* Under ideal conditions, either the appearance-of-objects method or 100-meter-unit-of-measure method is an effective method of estimating range. However, ideal conditions rarely exist on the battlefield, so the automatic rifleman must use a combination of methods. The terrain might limit the use of the appearance-of-objects method. For example, an automatic rifleman may not be able to see all the terrain out to the target; however, he may see enough to get a general idea of the distance. A slight haze may obscure many of the target details, but the automatic rifleman should still be able to judge its size. By carefully considering the ranges estimated by both methods, an experienced automatic rifleman should arrive at a figure close to the true range. The best way to reduce errors using these two methods is to train often.

6-12. LATERAL DISTANCE MEASUREMENT

In addition to estimating range accurately, the automatic rifleman needs a quick method of measuring lateral distance (right or left) from a reference point to a target. He can use his fingers to measure the lateral distance between a reference point and a target. He extends his arm with the palm outward, lowers the fingers, and locks the elbow. Then, he closes one eye, raises the index finger, and sights along its edge, placing the edge of the finger along the flank of the target or reference point. The space remaining between the points should be filled by raising fingers until the space is covered. He states the measurement from the reference point to the target as being one or more fingers, depending upon how many fingers are raised to cover this distance.

Section VI. ADVANCED AUTOMATIC RIFLE MARKSMANSHIP

Once the automatic rifleman masters the four fundamentals of automatic rifle marksmanship in the prone position and fighting position, he needs practice in applying the fundamentals in alternate positions and at targets that will most likely replicate the battlefield.

6-13. FIELD FIRING EXERCISE

The field firing exercise for the automatic rifleman exposes him to different types of targets at various ranges to simulate combat conditions.

a. **Objectives.** The objectives of this training are to reinforce the fundamentals and increase the effectiveness of the automatic rifleman by building his confidence. He must acquire targets quickly and deliver an accurate volume of fire.

b. **Organization.** The unit is assembled in the bleachers, given the training objectives, a range briefing, and a safety briefing. Automatic riflemen are then

organized into firing orders with a firer and a coach. (It is necessary to have concurrent training stations set up for those soldiers not actually on the firing line).

c. **Ammunition.** This exercise requires 148 rounds of 5.56-mm linked ammunition (zero is included). The automatic rifleman is allotted two 3-round bursts per target.

d. **Firing Sequence.** The sequence of firing will be conducted IAW Firing Table IV (Table 6-2, page 6-36).

(1) *Task 1, Field zeroing the 300-meter, single E-type silhouette.* The automatic rifleman is allocated 12 rounds of ammunition.

(2) *Task 2, Engage single E-type silhouettes from the prone and fighting position, bipod supported (point targets) at various ranges.* Targets are at 100, 200, 250, 300, and 400 meters. The automatic rifleman is allocated 30 rounds of ammunition.

(3) *Task 3, Engage double E-type silhouettes (automatic weapon positions) at various ranges.* Targets are at 250, 300, 400, 500, and 600 meters. The automatic rifleman is allocated 46 rounds of ammunition.

(4) *Task 4, Engage linear E-type silhouettes (troops on line) at various ranges.* Targets are at 300 and 600 meters. The automatic rifleman is allocated 60 rounds of ammunition.

NOTE 1: The 600-meter target should be engaged with 5- to 7-round bursts.

2: Commanders may score their soldiers to determine their most proficient automatic riflemen, to assess the marksmanship program, and to encourage competition.

TASK	RANGE (METERS)	TIME	TOTAL ROUNDS PER INDIV	TARGET	AMMO	TYPE FIRE
1	300	No limit	12	E-type silhouette	4 : 1	Zeroing 3-round bursts
2	100 200 250 300 400	60 sec	30	Single E-type silhouette	4 : 1	3-round bursts
3	250 300 400 500 600	120 sec	46	Single E-type silhouette Double E-type silhouette	4 : 1	3-round bursts 7-round bursts
4	300 600	120 sec	60	Linear target Single E-type 1 meter apart		3-round bursts 7-round bursts

Table 6-2. Firing Table IV.

6-14. ALTERNATE FIRING POSITIONS

All automatic riflemen must master the bipod-supported prone and fighting positions to be effective. But it is equally important that they know other positions. Each automatic rifleman must be trained to assume different positions quickly during various combat conditions. The situation ultimately determines the position. The automatic rifleman must establish his position so that he can effectively observe and engage the target yet minimize his exposure from enemy fire.

a. **Shoulder-Firing Position.** This position is usually used to engage targets at ranges less than 100 meters when no other position can be assumed or the situation dictates its use (Figure 6-25). It is the least stable of all positions, because the M249 AR is an open-bolt weapon that can be fired only on automatic. It is most often used in the final stages of the assault. To assume this position, the automatic rifleman—

- (1) Puts the bipod legs down so that he is prepared to assume the prone position when required.

(2) Puts his left foot well forward of the right. Leans forward at the waist toward the target with his knees bent, transferring his weight to his left foot before and during firing. This helps counter the recoil.

(3) Grasps the handguard firmly with his left hand. His left elbow is as nearly under the M249 as possible.

(4) With his right hand, places the butt of the M249 AR into the pocket of his right shoulder. Grasps the pistol grip firmly and pulls the weapon into his shoulder. Holds his right elbow horizontal to the ground or slightly above to form a good pocket in his shoulder. He does not use the shoulder rest.

(5) Lets his right arm absorb most of the weight of the weapon. Shifts his feet until he is aiming naturally at the target and obtains a good stockweld.

(6) Uses his left hand on the handguard to counter the tendency of the M249 AR to climb during burst fire.

(7) If there is not enough time to aim using the sights, applies quick-fire techniques. Looks through or just over the rear sight and uses the front sight post to aim at the target. Places the front sight post below the target (center base) and keeps his focus on the front sight post.

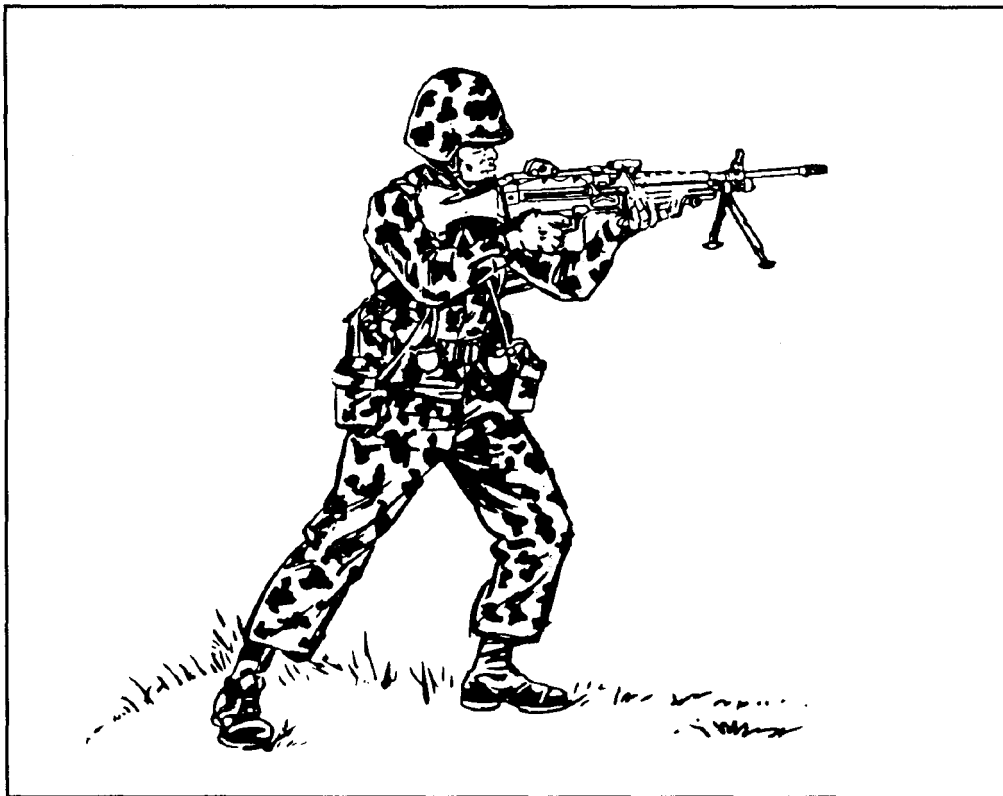

Figure 6-25. Shoulder firing position.

b. **Underarm Firing Position.** This position is used almost exclusively when moving and in and around the objective during the assault (Figure 6-26). To assume this position, the automatic rifleman—

- (1) Puts the bipod legs down for instant use in the prone position if necessary.
- (2) Faces the target with his feet spread about shoulder width apart.
- (3) Places his left foot in front of the right with most of his weight on his left foot.
- (4) Bends both legs at the knees and leans forward at the waist.
- (5) With his right hand, firmly grasps the pistol grip, and with his right forearm holds the stock firmly against the side of his body at a point between his armpit and waist.
- (6) With his left hand, grasps the handguard firmly.
- (7) Points his left foot in the direction of the target while his right foot provides stability.
- (8) Depresses the muzzle of the M249 AR slightly so the strike of rounds can be observed. This reduces shooting high and takes advantage of ricochets.
- (9) Leans toward the target before and during firing.



Figure 6-26. Underarm firing position.

c. **Hip Firing Position.** This position is used when closing with the enemy, when a heavy volume of fire in the target area is required, and when rapid movement is not necessary (Figure 6-27). The only differences between this position and the underarm position are—

- (1) The rear of the stock is held firmly against the forward position of the right thigh.
- (2) The arms are extended fully downward.

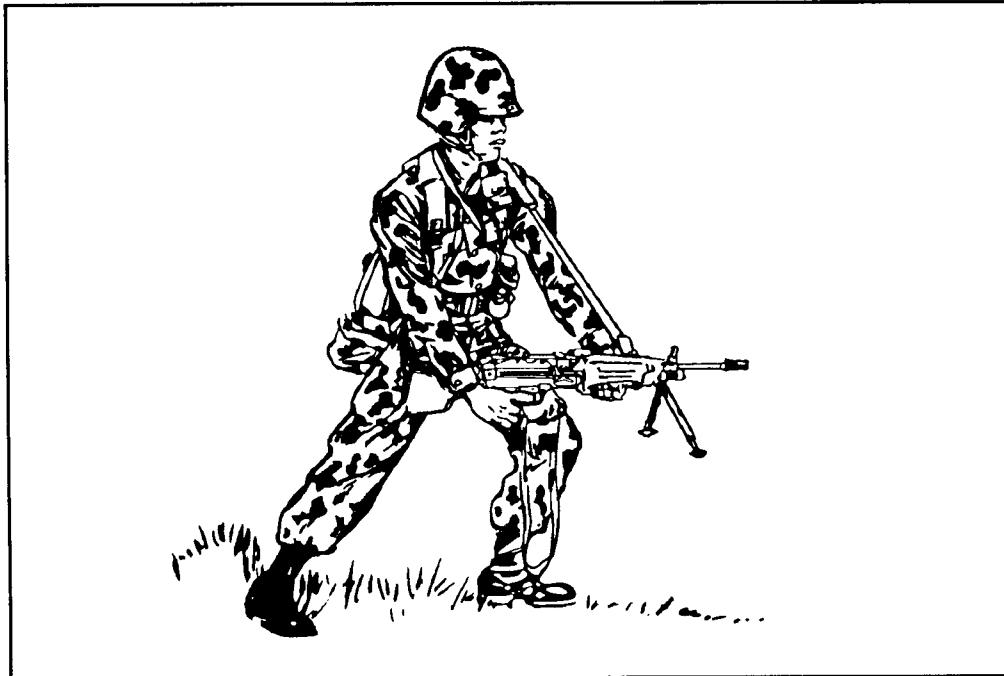

Figure 6-27. Hip firing position.

6-15. MOVEMENT, SPEED, AND ALIGNMENT

The automatic rifleman must keep up with the other soldiers of the assaulting element through individual movement techniques. To do this, he moves as rapidly as possible, consistent with his ability to fire accurately and maintain alignment.

6-16. RELOADING

The automatic rifleman must reload rapidly to avoid lulls in the firing. This can be achieved by practicing and by applying the following techniques.

- a. Before the assault, the automatic rifleman conducts prefire checks on the weapon. He inspects ammunition to ensure that it is clean and serviceable, and he checks the box for serviceability.

b. During the assault, the automatic rifleman must continue moving forward and reload as rapidly as possible. The sling allows the automatic rifleman to reload using both hands.

6-17. ALTERNATE FIRING POSITION EXERCISES

The assault fire exercise challenges the automatic rifleman, It consists of point and area targets under a variety of conditions replicating the battlefield. These exercises, which involve fire and maneuver, must be carefully controlled for safety purposes.

a. **Objectives.** This exercise gives the automatic rifleman practice on engaging targets as quickly as possible, using any of the alternate firing positions.

b. **Organization.** The unit is assembled in the bleachers, given instructions, and briefed on training that will be conducted while they are on the range. After the briefing, they are organized into firing orders and moved to firing lanes. Lanes are conducted and used IAW local range policies.

c. **Ammunition.** This exercise requires a total of 75 rounds of 5.56-mm linked ammunition. The automatic rifleman is allowed two 3-round bursts per exposure, and he is also required to conduct at least one rapid reload during the exercise. The commander has the option as to when the rapid reload may take place. Ammunition is configured into two belts of any size that requires the automatic rifleman to reload.

d. **Firing Sequence.** The sequence of firing is conducted IAW Firing Table V (Table 6-3). The suggested sequence of firing is as follows.

(1) *Task 1, Dry fire walk-through.* Upon his arrival at the firing position, the automatic rifleman walks through his respective lane to become familiar with the targets. No ammunition is fired at this time. When he returns, he draws his ammunition.

NOTE: Commanders should ensure that ammunition is used in such a manner that it requires the automatic rifleman to rapidly reload sometime during his movement phases.

(2) *Task 2, Engage single E-type silhouette from the hip firing position.* After being issued the ammunition, the automatic rifleman begins his movement. When targets are exposed, he uses the hip firing technique. He will be given a single exposed target at a distance of 25 meters, with an exposure time of 5 seconds for each target.

(3) *Task 3, Engage single E-type silhouettes from the underarm firing position.* As the automatic rifleman continues to move through the course, he will then be given two single exposed E-type silhouettes at distances of 50 and 25 meters, where he will engage each silhouette using the

underarm-firing position. The exposure time for these targets will be 5 seconds per target.

(4) *Task 4, Engage single E-type silhouettes from the shoulder firing position.* Once the automatic rifleman reaches the shoulder firing position, he will be given three single exposed E-type silhouettes at distances of 25, 50, and 75 meters. The exposure time for each target will be 5 seconds.

NOTE: The commander may integrate firing under NBC conditions for selected tasks while negotiating the course, or he may conduct the course during limited visibility unaided.

TASK	RANGE (METERS)	TIME	TOTAL ROUNDS PER INDIV	TARGET	AMMO	TYPE FIRE
1	N/A	No limit	N/A	N/A	N/A	N/A
2	25	5 sec	6	Single E-type silhouette	4:1	3-round bursts
3	50 25	10 sec	12	Single E-type silhouette	4:1	3-round bursts
4	25 50 75	15 sec	18	Single E-type silhouette	4:1	3-round bursts

Table 6-3. Firing Table V.

CHAPTER 7

TRAIN-THE-TRAINER PROGRAM

This manual and other training publications provide the trainers with the information they need for unit training. This chapter is an aid for the chain of command, who are the primary trainers, to develop a good train-the-trainer program. Knowledgeable, small-unit leaders and trainers are the key to successful, marksmanship training; however, the entire chain of command must be involved in the execution of training to standard.

Section I. ORGANIZATION

An effective train-the-trainer program reflects the priority, emphasis, and interest of the chain of command and trainers to see that execution of training to standard is scheduled. This section provides guidance needed to develop METLs, to assess performance proficiency, and to assign the responsibilities of the chain of command, trainers, and coaches.

7-1. OBJECTIVES

The objectives of the train-the-trainer program include developing in every automatic rifle trainer the confidence, willingness, knowledge, and skills required to consistently train their soldiers to be effective in combat. The program's aim is—

- a. To train the trainer to apply the principles of M249 AR marksmanship.
- b. To ensure that every trainer maintains a constant degree of proficiency in applying the principles of AR instruction.
- c. To provide a maximum number of trainers from which potential trainers may be selected for further weapons training.

7-2. MISSION-ESSENTIAL TASK LIST

Marksmanship is critical and basic to soldiering. Each commander should develop a METL and organize a training program that devotes adequate time to marksmanship. The unit's combat mission must be considered when establishing training priorities. This not only applies to the tasks selected but also to the conditions under which the tasks are to be performed. The tasks for the METL are developed for both defensive and offensive operations.

7-3. TRAINER ASSESSMENT

The chain of command is also involved in determining the proficiency of potential trainers by reviewing the following information.

a. **Selection.** Trainers should be selected from the most highly qualified soldiers available within the unit. These soldiers should display knowledge of the M249 automatic rifle, a high degree of proficiency in applying the fundamentals, and a motivated attitude for marksmanship training ability. The chain of command must ensure that a high level of expertise is maintained. Knowledgeable trainers are the key to marksmanship.

b. **Trainer Course.** Once the chain of command has identified these soldiers possessing the required knowledge, skills, and motivation in M249 marksmanship, they must then ensure this knowledge can be effectively taught to other soldiers.

c. **Training.** There are several available means that may be used in the progression of trainer training or that can easily be tailored to the particular needs of the command. The more time and training initially invested, the better the trainer will be. The chain of command should periodically evaluate each trainer and replace any that loses his motivation or desire. To maintain interest in the program, commanders should promote competitive awards, such as the Trainer of the Month.

7-4. CADRE COACHES

Assisting the trainer and coaching a soldier to fire the M249 AR are highly technical jobs that must be done well. The most valuable soldiers in the program are those who not only have obtained a high standard, but those who can effectively teach this knowledge to others. Once the individual is consistent as an automatic rifleman, he can then develop into a competent coach. It is worth the effort to train the qualified automatic rifleman to become a successful coach, because experience has shown that such training also develops leadership ability.

a. The primary responsibility of coaches is to train individuals in the effective use of the M249 automatic rifle. In addition, coaches are responsible for enforcing safety regulations. They must maintain strict discipline on the firing lane at all times and constantly enforce compliance with the range regulations and training guidance.

b. To be a coach, a soldier must know the principles of accurate firing and coaching techniques, and he must have the following qualifications as well.

(1) *Knowledge.* The coach must know this manual. He must be prepared to accurately answer any question on the subject of marksmanship. Then, he must develop his ability to observe the actions of the soldier quickly and to correct them with sound recommendations.

(2) *Patience.* Automatic riflemen can be persuaded to accept the principles and procedures by patient repetition and demonstration.

(3) *Understanding.* A coach with a good “firing lane manner” enhances success. Training new automatic riflemen is stressful to the soldiers and the trainers. The soldier may be sensitive to abruptness, impatience, or a lack of sympathy with his difficulties; and he will immediately react unfavorably to evidence of such attitude on the part of the coach.

(4) *Consideration.* Most soldiers, even those who do not fire well, enjoy firing and begin with a positive interest in their performance on the range. If the coach is considerate of his pupils’ feelings from the beginning and encourages them throughout their training, he will find coaching a pleasant and rewarding duty.

(5) *Ability to maintain respect.* When a soldier is assigned the duties of coach, he too is an expert and should receive the same respect as the primary trainer. The coach must retain that respect throughout his contact with students by showing a thorough knowledge of his subject in a dignified manner.

(6) *Alertness.* Even the most capable student may forget or neglect some essential point in his instruction in the excitement of firing on the range. The coach must always be alert and patiently correct him as often as necessary. He must keep the automatic rifleman encouraged throughout his instruction by making the most of all progress. The coach must not allow his students to become discouraged or to lose interest.

(7) *Helpful attitude.* In coaching on the range, as in most other lines of instruction, a combative, hard-boiled attitude is rarely effective.

(8) *Ability to provide encouragement.* The coach can encourage his soldiers by convincing them there is no mystery about good firing: The weapon and ammunition are developed mechanically for accuracy. The coach is there to assist the automatic rifleman to gain experience that produce a good marksman.

7-5. COMMAND BENEFITS

Through the active and aggressive leadership of the chain of command, a perpetual base of expertise is established and maintained. The unit’s esprit de corps is significantly raised through the trainers’ desire to improve and demonstrate they are the best. The goal of a progressive train-the-trainer program is to achieve a high state of combat readiness.

7-6. PROGRAM PHASES

Since firing is a learning process, certain prerequisites must be satisfied before a trainer should pass from one phase of marksmanship to another. To obtain maximum results on the battlefield, the automatic rifleman must be trained in fundamentals before engaging a combat target. The phases of the train-the-trainer program develop this structure in the most progressive manner. They are sequenced to train the trainer in teaching tasks necessary to produce a quality M249 automatic rifleman.

a. **Preliminary Marksmanship.** The automatic rifleman receives this training before live firing. It is during this phase that sound foundations of good firing principles are constructed, reviewed, and reinforced. The degree of proficiency obtained or retained by the automatic riflemen depends on the foundation built during this phase. Correct firing and safety habits must become so fixed they become natural. Drilling of the fundamentals and continued leader emphasis will bring the greatest return in the shortest time. Proper firing is a physical skill, which must be learned. When practiced, the process becomes a learned skill that will be retained. However, good firing is a perishable skill. All firers must periodically familiarize themselves with the fundamentals regardless of their years of marksmanship experience. Even experienced automatic riflemen will develop a deficiency in applying certain fundamentals.

b. **Basic Marksmanship.** This training teaches the trainers how to set up and conduct 10-meter and transition firing exercises on the available ranges.

c. **Advanced Marksmanship.** This training teaches the trainer how to develop teamwork among the automatic riflemen. This gives them confidence in their ability to deliver a large volume of accurate fire against targets. During this phase, the trainer is responsible for the conduct of assault firing exercises. These exercises consist of assault fire, NBC assault fire, and field fire on available ranges.

Section II. TRAINING TASKS

This section assists trainers in effectively training soldiers assigned to the M249 automatic rifle. It explains the tasks, organization, equipment needed, and instruction sequence for the three phases of training. However, unit SOPs or post regulations may direct increases or decreases in these prescribed requirements.

7-7. PHASE I, PRELIMINARY MARKSMANSHIP TRAINING

This phase covers the basics that each trainer must know to teach the general care and maintenance of the M249 AR (Chapter 2.)

a. Task 1: Disassemble the M249.

(1) *Equipment needed.* A table is needed for placement of M249 so the soldiers may better see the removal of parts. Nomenclature charts or mats are material aids in explaining mechanical training, and they help the automatic riflemen learn the nomenclature of parts.

(2) *Class organization.* One coach is assigned for each group (weapon) if possible; otherwise, coaches are placed where they can supervise assigned groups.

(3) *Sequence of training.* The trainer presents a brief history of the weapon. He stresses the combat role it has played and the mission it is assigned. He emphasizes the purpose, scope, and importance of the instruction to be presented. He gives a brief description of the operation, general data, and exterior nomenclature of the weapon. Coaches should disassemble the weapon as the trainer explains the procedures. The automatic riflemen then practice until they become skilled in disassembly and can demonstrate this task to a coach. This often encourages soldiers to practice during free time and develops their individual skill and initiative. The trainer stresses that this task is not done hurriedly, because the soldiers may damage parts of the weapon.

b. Task 2: Inspect the M249.

(1) *Equipment needed.* The trainer needs one cleaning rod and one dummy round for each weapon, bore cleaner, lubricating oil, patches, and rags. The trainer displays all the available cleaning materials, lubricants, and rust preventatives.

(2) *Class organization.* Same as Task 1.

(3) *Sequence of training.* The trainer emphasizes meticulous cleaning, lubrication, inspection, and preventive maintenance to ensure performance. The care and cleaning period is used to further the automatic riflemen's knowledge of the nomenclature and skill in disassembly. The trainer emphasizes inspection, care, and preventive maintenance during combat conditions, which is the final test of the weapon maintenance program. Practical work is conducted. The trainer points out the differences in care and cleaning following an NBC attack. He emphasizes the importance of frequent inspection as a means of ensuring proper maintenance of the weapon.

c. Task 3: Clean the M249.

(1) *Equipment needed.* Same as Task 2.

(2) *Class organization.* Same as Task 1.

(3) *Sequence of training.* Same as Task 2.

d. Task 4: Lubricate the M249.

- (1) *Equipment needed.* Same as Task 2.
- (2) *Class organization.* Same as Task 1.
- (3) *Sequence of training.* Same as Task 2.

e. Task 5: Assemble the M249.

- (1) *Equipment needed.* Same as Task 1.
- (2) *Class organization.* Same as Task 1.
- (3) *Sequence of training.* Coaches should assemble the weapon as the trainer explains the procedures. The automatic riflemen practice until they become proficient in assembly and can demonstrate this task to a coach.

f. Task 6: Explain the Operation of the M249. (Chapter 3.)

- (1) *Equipment needed.* One M249 AR, placed on a table; one belt of five dummy rounds; and a cleaning rod for each automatic rifleman.
- (2) *Class organization.* Same as Task 1.
- (3) *Sequence of training.* The trainer explains and demonstrates loading, unloading, and clearing the weapon. He stresses the safety factors involved. He demonstrates letting the bolt go forward when the barrel is out of the weapon.

g. Task 7: Explain the Functioning of the M249.

- (1) *Equipment needed.* One M249 AR for each soldier as in previous mechanical training instruction. Graphic training aids are useful if the class is about platoon size; otherwise, GTAs may be made available for study and discussion during breaks.
- (2) *Class organization.* Same as Task 1.
- (3) *Sequence of training.* Functioning is divided in eight steps—feeding, cambering, locking, firing, unlocking, extracting, ejecting, and cocking. Coaches should duplicate each demonstration on the weapons with each group. (Chapter 3.) Functioning is taught by seeing how the parts work, rather than by memorizing the text. The trainer tests retention of the training by asking questions concerning the steps of functioning.

h. Task 8: Explain Malfunction, Stoppage, and Immediate Action. (Chapter 4.)

- (1) *Equipment needed.* Same as Task 1.
- (2) *Class organization.* Same as Task 1.
- (3) *Sequence of training.* Malfunction and stoppages charts may be used as a guide in presenting instruction. These charts may be available from the local Training Support Center or the trainer can use Table 4-1 and Table 4-2 in this manual. The trainer stresses precision in detecting the cause and reducing stoppages. As the automatic riflemen progress, the trainer has them concentrate on speed in applying immediate action and other methods

of reducing a stoppage. He stresses safety precautions in connection with a hangfire or cookoff.

i. Task 9: Demonstrate Fundamentals of Marksmanship. (Chapter 5.)

(1) *Equipment needed.* One M249 and basic machine gun targets for each firing lane on a range equipped with a prone and fighting position.

(2) *Class organization.* The maximum required number of automatic riflemen are on the firing line.

(3) *Sequence of training.* The trainer conducts conference, demonstration, and practical work on the fundamentals of marksmanship (steady position, aim, breath control, trigger control, and firing position).

j. Task 10: Demonstrate Fundamentals of Firing Positions.

(1) *Equipment needed.* Same as Task 9.

(2) *Class organization.* Same as Task 9.

(3) *Sequence of training.* Same as Task 9.

k. Task 11: Demonstrate Fundamentals of Engaging Night, NBC, and Moving Targets.

(1) *Equipment needed.* Same as Task 9, plus AN/PVS-4 per weapon and protective mask and gloves for each automatic rifleman on the firing line.

(2) *Class organization.* Same as Task 9.

(3) *Sequence of training.* Same as Task 9.

l. Task 12: Demonstrate Fundamentals of Traverse and Search.

(1) *Equipment needed.* Same as Task 9.

(2) *Class organization.* Same as Task 9.

(3) *Sequence of training.* Same as Task 9.

m. Task 13: Demonstrate Fire Commands.

(1) *Equipment needed.* Same as Task 9.

(2) *Class organization.* Same as Task 9.

(3) *Sequence of training.* Same as Task 9, plus trainer gives the fire commands.

n. Task 14: Execute Dry-Fire Exercises.

(1) *Equipment needed.* Same as Task 9.

(2) *Class Organization.* Same as Task 9.

(3) *Sequence of training.* Same as Task 9.

7-8. PHASE II, BASIC MARKSMANSHIP TRAINING

The information learned in this phase is essential to the development of the trainer who is to conduct the 10-meter firing with NBC, day transition with NBC, and night transition instructional firing for the M249. (Chapter 5.)

a. Task 15: Conduct 10-Meter Firing.

(1) *Equipment needed.* One M249 and basic machine gun targets for each firing lane; stopwatches; patches; and cleaning rods. Sound equipment is desirable during firing.

(2) *Class organization.* The maximum number of automatic riflemen are on the firing line with the remainder receiving concurrent instruction in the rear training area.

(3) *Sequence of instruction.* The trainer conducts conference, demonstration, and practical work on emplacing the weapon on the firing lane. He places emphasis on preparation of the weapon for firing, including safety checks. The interval between the two portions of the control command should be sufficient to permit the execution of the command and to allow the coach to perform his duties. Coaches are required to perform their duties quickly and precisely. During practice, the trainer must ensure that the automatic rifleman is in the proper position before he is permitted to shoot.

b. Task 16: Conduct Daytime Transition Fire on the Multipurpose Machine Gun Range.

(1) *Equipment needed.* One M249 for each firing lane, single and double E-type silhouette targets, and cleaning rods. Sound equipment is desirable during firing.

(2) *Class organization.* Preferably, one automatic rifleman and one coach for each firing lane. Personnel not required in the operation of the range should receive concurrent training in rear area.

(3) *Sequence of instruction.* Before the conference and demonstration of firing, the trainer briefly reviews range estimation and techniques of adjustment. He also explains the characteristics of AR fire and their effect on field targets. The weapons are zeroed at a known distance on the transition range (preferably at 300 meters). The automatic rifleman receiving the instruction should do the zeroing. The lane NCO requires the automatic rifleman to be in the correct position before letting him fire. The acting safety NCO may assist the automatic rifleman in locating the targets, but he is not permitted to aid in range estimation or fire adjustment. At the completion of the exercise, the next automatic rifleman moves up. Appropriate subjects to be included in the rear-area training are—

- Mechanical training.
- Any other AR subjects in which additional training is needed.

c. Task 17: Conduct Nighttime Transition Fire.

(1) *Equipment needed.* One M249 for each firing lane, appropriate targets, cleaning rods, oil, and patches. Sound equipment is desirable during firing.

(2) *Class organization.* The firing area should have seating for the entire group during conferences. After the conference, the group is divided into small groups for practical work under the control of the coaches. The OIC controls all firing. If space permits, all personnel are placed on the firing line. Requirements for the various exercises should be simple and progressive. If possible, the trainer selects terrain for the subject; otherwise, he applies the subject to the terrain.

(3) *Sequence of instruction.* Before the conference and demonstration, the trainer conducts the preparatory exercises of mounting the AN/PVS-4 and seating, boresighting, and zeroing procedures for the device. He should also review and discuss range estimation, techniques of fire, adjustment, and characteristics of automatic fire. The weapon should be zeroed to the device using the night fire procedures in Chapter 5. The acting safety NCO for each lane requires the automatic rifleman to be in the correct position before letting him fire. At the completion of the exercise, the next automatic rifleman moves up. Appropriate subjects to be included in the rear training area are—

- Mechanical training.
- Care and cleaning.
- Any other subjects in which additional training is needed.

7-9. Phase III, ADVANCED MARKSMANSHIP TRAINING

This training phase enables the trainer to develop his advanced skills such as shoulder-, underarm-, and hip-firing positions and rapid reload techniques. (Chapter 6.)

a. Task 18: Conduct Daytime Assault Fire.

(1) *Equipment needed.* One M249 and appropriate ammunition for each firing lane.

(2) *Class organization.* The multipurpose machine gun transition range is used if the installation has one. If need be, the lanes are modified so the automatic rifleman has a trail of at least 150 meters in front of the weapon position. The training area should have seating for the entire group during conferences. After the conferences, the group is divided into firing orders. If the group is large, two firing orders are placed on the firing line and all other personnel go to the concurrent training area for practical work under the control of the coaches. The OIC controls all firing. If the group is small, all personnel go to the firing line at once. Requirements for the various exercises should be simple and progressive. If possible, the trainer selects terrain for the subject; otherwise, he applies the subject to the terrain.

(3) *Sequence of instruction.* The unit is assembled, given instructions, and briefed on the training that will be conducted while they are on the range. After the briefing, they are organized into firing orders and moved to firing lanes. Lanes are conducted IAW local range policies. Firing is conducted as described in Chapter 6. Concurrent training stations, using sand tables, charts, diagrams, or terrain, are set up to review assault firing techniques using the—

- Shoulder firing position.
- Underarm firing position.
- Hip firing position,
- Rapid reloading techniques.

b. Task 19: Conduct NBC Assault Fire With the M249.

(1) *Equipment needed.* Protective mask and gloves, one M249, and appropriate ammunition for each firing lane.

(2) *Class organization.* Same as for Task 15.

(3) *Sequence of instruction.* The unit is assembled, given instructions, and briefed on the training that will be conducted while they are on the range. After the briefing, they are organized into firing orders and moved to firing lanes. Lanes are conducted IAW local range policies. Firing is conducted as described in Chapter 6. Concurrent training stations, using sand tables, charts, diagrams, or terrain, are set up to review assault firing techniques using the—

- Shoulder firing position while wearing a protective mask and gloves.
- Underarm firing position while wearing a protective mask and gloves.
- Hip firing position while wearing a protective mask and gloves.
- Rapid reloading techniques while wearing a protective mask and gloves.

Section III. TRAINER CERTIFICATION PROGRAM

The certification program sustains the trainers' expertise and develops methods of training. The program standardizes procedures for certifying M249 marksmanship trainers. Trainers' technical expertise must be continuously refreshed, updated, and closely managed.

7-10. TRAINING BASE

The training base can expect the same personnel changes as any other organization. Soldiers assigned as M249 trainers will have varying experience and knowledge of training procedures and methods. Therefore, the trainer

certification program must be an ongoing process that is tailored to address these variables. As a minimum, formal records document program progression for each trainer. All M249 trainers must complete the three phases of training using the progression steps, and they must be updated on a quarterly basis. One of the goals of the program is for the trainer to know the training mission.

7-11. CERTIFICATION PROGRAM OUTLINE

All trainers must attend, then conduct, all phases of the train-the-trainer program. Trainers are certified who demonstrate the ability to train soldiers, to diagnose and correct problems, and to achieve standards. Those trainers who fail to attend or fail any phase of the diagnostic examination will be assigned to subsequent training. The personnel designated to present instruction must complete the phases of the program in the sequence described.

a. **Phase I, Program Orientation.** During this phase, the trainer must accomplish the following tasks and be certified by the chain of command.

- (1) Be briefed on the concept of the certification program.
- (2) Be briefed on the unit's marksmanship training strategy.
- (3) Review the unit's marksmanship training outlines.
- (4) Review issued reference material.
- (5) Visit training sites and firing ranges.

b. **Phase II, Preliminary Marksmanship Training.** During Phase II, the trainer must demonstrate his ability to master the fundamentals of marksmanship. Phase II should be completed within two weeks after Phase I. The following fundamentals must be reviewed by the chain of command. The results of this review are recorded and maintained on a trainer's progression sheet, which is designed in accordance with the unit's SOP.

- Characteristics.
- Capabilities.
- Disassembly.
- Clean, lubricate, and inspect.
- Assembly.
- Range determination and estimation.
- Classes of fire.
- Application of fire.
- Fire commands.
- Loading.

- Unloading.
- Immediate actions.
- Sight manipulations.
- Traverse and search exercise.

c. **Phase III, Basic Marksmanship Training.** During this phase, the trainer must set up and conduct firing on the various ranges. He must explain the targets and zeroing and scoring procedures. The trainer must explain the purpose of transition firing, field zero procedures, range layout, and the conduct of training on the transition range. This briefing to the chain of command validates the trainer's knowledge necessary to conduct training. The results of this interview are recorded on the trainer's progression sheet.

d. **Phase IV, Advanced Marksmanship Training.** This is the final phase of the train-the-trainer program and tests the trainer. The trainer must set up a range and conduct training of at least one person. If ammunition is available, the trainer conducts a firing exercise. If ammunition is not available, the testing is based on the quality of training given.

APPENDIX A

UNIT TRAINING PROGRAM

A unit training program must focus on three battlefield variables to be effective: the nature of the target (moving or stationary, single or multiple); the nature of the firer (stationary or moving); and the conditions (full or limited visibility, with or without protective mask, day or night). The training program must prepare the unit for war by enabling soldiers to develop and sustain proficiency in M249 tasks for both leader and soldier. This includes not just individual training but the evaluation of soldier proficiency. Good preliminary marksmanship training is an integral part of training before and between firings. Individual training must be integrated with battle drills and other collective training to ensure the program prepares the unit for war. This appendix provides guidance for conduct and performance of unit training during preliminary marksmanship training for the M249 automatic rifle. This proposed training program for units with the bipod-mounted M249 AR is subdivided into the following periods:

- Introduction.
- Preliminary marksmanship training and dry fire.
- Proficiency (performance) examination.
- 10-meter zero practice and qualification. (NBC is integrated.)
- Transition range, field zero, and practice firing. (NBC is integrated.)
- Transition range qualification firing. (NBC is integrated.)
- Night zero and instructional firing.
- Night practice firing.

A-1. PERIOD I—INTRODUCTION (3-HOUR PERIOD)

After a brief description of the weapon, soldiers receive the following instruction.

Disassembly and Assembly	Time Allowed
Disassembly.	25 minutes
Operator maintenance:	
Inspection.	10 minutes
Cleaning.	10 minutes
Lubrication.	10 minutes
Assembly.	25 minutes
Disassembly and assembly (practice exercise–optional).	50 minutes
	<hr/>
	Subtotal 2 hours 10 minutes

Characteristics of Fire	Time Allowed
Burst fire.	15 minutes
Trajectory and beaten zone.	15 minutes
Engagements of targets:	
Point.	10 minutes
Area.	10 minutes
	50 minutes
Subtotal	
TOTAL	3 hours

**A-2. PERIOD 2—PRELIMINARY MARKSMANSHIP
TRAINING AND DRY FIRE (3-HOUR PERIOD)**

After a brief description of the training to be conducted, soldiers receive the following instructions on the M249 AR.

Techniques of Fire	Time Allowed
Position and grip, aiming, and trigger manipulation.	30 minutes
Loading belt and magazine ammunition.	15 minutes
Reducing stoppages and clearing the weapon.	15 minutes
	1 hour
Subtotal	

Dry-Fire Practice	Time Allowed
Aiming and firing sequence.	30 minutes
Sight setting and sight changes.	30 minutes
Zeroing procedures.	1 hour
	2 hours
Subtotal	
TOTAL	3 hours

**A-3. PERIOD 3—PROFICIENCY (PERFORMANCE)
EXAMINATION (1-HOUR PERIOD)**

This period tests and evaluates tasks learned in Periods 1 and 2. The proficiency examination described in Appendix B may be used in this period of instruction.

TOTAL	1 hour
-------	--------

A-4. PERIOD 4—10-METER ZERO PRACTICE AND QUALIFICATION (4-HOUR PERIOD)

Instructional Subperiods	Time Allowed
Preliminary marksmanship training including the four fundamentals and bipod positions.	30 minutes
Function checks, loading, immediate action, clearing, and range safety.	15 minutes
Introduction to the 10-meter firing (includes zeroing and practice qualification with NBC integrated on the 10-meter target, and scoring of the target).	15 minutes
Zero firing.	1 hour
Practice day (NBC integrated) Table I.	1 hour
Qualification day (NBC integrated) Table I.	1 hour
TOTAL	4 hours

A-5. PERIOD 5—TRANSITION RANGE PRACTICE FIRING (4-HOUR PERIOD)

Instruction	Time Allowed
Introduction to field firing (includes the transition range organization and operation).	15 minutes
Fire standard qualification course for practice (IAW with procedures in Chapter 5).	3 hours, 45 minutes
TOTAL	4 hours

A-6. PERIOD 6—TRANSITION RANGE QUALIFICATION FIRING (NBC INTEGRATED) (4-HOUR PERIOD)

Soldiers fire the standard qualification course for record IAW procedures in Chapter 5.

TOTAL	4 hours
--------------	----------------

**A-7. PERIOD 7—NIGHT ZERO, INSTRUCTIONAL,
AND PRACTICE FIRING (4-HOUR PERIOD)**

Soldiers receive instruction on mounting, placing the AN/PVS-4 into operation, boresighting, and zeroing the device once it is seated. They fire standard night course as Period 6, except an AN/PVS-4 is mounted on the weapon.

TOTAL 4 hours

A-8. SUMMARY OF HOURS

Period 1	3
Period 2	3
Period 3	1
Period 4	4
Period 5	4
Period 6	4
Period 7	4
TOTAL	23 hours

A-9. SUMMARY OF AMMUNITION REQUIRED

Period 4, Table I	108 rounds (zero, practice, and qualification)
Periods 5 and 6, Table II	144 rounds (zero, practice, and qualification)
Period 7, Table III	90 rounds (seat, boresight, zero, instructional, and practical)
TOTAL	342 rounds

APPENDIX B

PROFICIENCY (PERFORMANCE) EXAMINATION

The proficiency examination determines whether the soldier can perform all the tasks taught in the dry-fire training. This appendix provides a guide for administering the examination to automatic riflemen.

B-1. DRY-FIRE PROFICIENCY EXAMINATION

The examination is a practical nonfiring exercise given during the last period of the M249 AR block of instruction before range firing. It does not have to be conducted on a range and may be held indoors if there are available facilities. The soldier must demonstrate techniques for the following tasks:

- General disassembly and assembly.
- Loading and unloading.
- Immediate action and remedial action.
- Field zeroing.
- Engagement of a linear and a deep target.

B-2. CONDUCT OF THE EXAMINATION

The commander can use the following schedule or modify it to fit his unit's training.

- Orientation, instructions, breakdown, and movement—15 minutes.
- Five stations—30 minutes each.
- Two breaks—10 minutes each.
- Four movement periods—5 minutes each.
- Total time—3 hours and 25 minutes.

B-3. STATION 1: GENERAL DISASSEMBLY AND ASSEMBLY

This station normally has 11 setups. Each setup has one M249 AR with cover feed mechanism assembly raised, bolt forward, and safety on the FIRE position. This is placed on a mat to keep the parts free of dirt.

- a. The following statement should be read at this station.

DURING THIS PERIOD, YOU WILL BE ORGANIZED INTO THREE GROUPS AND REQUIRED TO DISASSEMBLE AND ASSEMBLE THE M249 AUTOMATIC RIFLE. THERE WILL BE ONE AUTOMATIC RIFLE FOR EACH INDIVIDUAL AND ONE GRADER FOR EVERY TWO AUTOMATIC RIFLEMEN. EACH GROUP WILL BE ALLOWED FOUR MINUTES TO COMPLETE GENERAL DISASSEMBLY AND FOUR MINUTES FOR ASSEMBLY. IF YOU HAVE ANY TROUBLE, RAISE YOUR HAND AND THE GRADER WILL ASSIST YOU. THE TWO GROUPS NOT BEING TESTED WILL REMAIN TO THE REAR OF THE STATION WITH THEIR BACKS TOWARD THE WORKING AREA UNTIL THEY ARE CALLED.

b. A scoresheet, like the example in Figure B-1, should be used in grading individual performance.

<p>Station 1 GENERAL DISASSEMBLY AND ASSEMBLY CHECKLIST</p> <ol style="list-style-type: none"> 1. Cleared M249 AR using the procedures prescribed in Chapter 2. 2. Disassembled M249 AR as prescribed in Chapter 2 and as follows: <ol style="list-style-type: none"> (a) Removed the operating rod group. (b) Removed the barrel group and separated the gas regulator and collar. (c) Removed the handguard group. (d) Removed the buttstock and buffer assembly group. (e) Removed the trigger mechanism group. (f) Removed the gas cylinder group. (g) Removed the bipod group. (h) Separated assemblies in the receiver group. 3. Reassembled M249 AR in the reverse order as previously described. 4. Accomplished disassembly correctly in 4 minutes. 5. Accomplished assembly correctly in 4 minutes.
--

Figure B-1. Example Station 1 scoresheet.

B-4. STATION 2: LOAD AND UNLOAD THE M249 AR

This station normally has 11 setups. Each setup has one M249 AR.

a. For the first step, the grader should ensure that any procedures that must be conducted by the automatic rifleman are not set up for easier accomplishment. He is required to use either the belted or magazine ammunition. The second step should be the same as the first, except the automatic rifleman will unload the weapon.

b. The following statement should be read at this station.
DURING THIS PERIOD, YOU WILL BE ORGANIZED INTO THREE GROUPS, AND YOU WILL BE REQUIRED TO LOAD AND UNLOAD THE M249 AUTOMATIC RIFLE. A GRADER WILL CHECK AND SCORE YOUR PROCEDURES. YOU WILL BE ALLOCATED A FOUR-MINUTE WORK PERIOD AT THIS STATION. IF YOU HAVE ANY TROUBLE, RAISE YOUR HAND AND THE GRADER WILL ASSIST YOU. THE TWO GROUPS NOT BEING TESTED WILL REMAIN TO THE REAR OF THE STATION WITH THEIR BACKS TOWARD THE WORK AREA UNTIL THEY ARE CALLED.

c. A scoresheet, like the example in Figure B-2, page B-4, should be used in grading individual performance.

Station 2
LOAD AND UNLOAD THE M249
CHECKLIST

1. Loaded the M249 IAW Chapter 3 as follows:
 - (a) Placed safety on FIRE.
 - (b) Pulled and locked cocking handle to the rear.
 - (c) Placed safety on SAFE.
 - (d) Pushed locking handle forward.
 - (e) Raised the cover and feed mechanism assembly.
 - (f) Placed the lead link tab or first round in the tray, or inserted the magazine (M16A1 or A2).
2. Unloaded the M249 IAW Chapter 3 as follows:
 - (a) Pulled and locked cocking handle to the rear.
 - (b) Placed safety on SAFE.
 - (c) Pushed cocking handle forward.
 - (d) For belt ammunition—raised the cover and feed mechanism assembly and performed the five-point safety check.
 - (e) For magazine ammunition—pushed down on the release tab, pulled out the magazine, and performed the five-point safety check.
3. Accomplished in 60 seconds.

Figure B-2. Example Station 2 scoresheet.

d. As each group completes this station, each grader should assemble the individuals he graded and give them a thorough critique (6 minutes).

**B-5. STATION 3: IMMEDIATE ACTION AND
REMEDIAL ACTION**

This station normally has six setups. Each setup has a cleaning rod and a bipod-mounted M249 AR with bolt forward, cover feed mechanism assembly closed, and safety on FIRE position.

a. The grader should ask the individual to perform immediate action as he would if a round were in the chamber.

b. The following statement should be read at this station.

DURING THIS PERIOD, YOU WILL BE ORGANIZED INTO FIVE GROUPS AND REQUIRED TO GO THROUGH THE STEPS OF IMMEDIATE ACTION AND REMEDIAL ACTION WITH THE M249 AUTOMATIC RIFLE. YOU WILL BE ALLOWED FIVE MINUTES. IF YOU HAVE ANY TROUBLE, RAISE YOUR HAND AND A GRADER WILL ASSIST YOU. THE GROUPS NOT BEING TESTED WILL REMAIN TO THE REAR OF THE STATION WITH THEIR BACKS TOWARD THE WORK AREA UNTIL THEY ARE CALLED.

c. A scoresheet, like the example in Figure B-3, should be used in grading individual performance.

<p style="text-align: center;">Station 3 IMMEDIATE ACTION AND REMEDIAL ACTION CHECKLIST</p> <p>1. Immediate action:</p> <ul style="list-style-type: none">a. Pulled the cocking handle to the rear.b. Observed the ejection port for cartridge case, belt link, or round.c. Pushed cocking handle to its forward position.d. Pressed the trigger. <p>2. Remedial action (if weapon still malfunctions):</p> <ul style="list-style-type: none">a. Pulled bolt back to the rear.b. Moved safety to SAFE.c. Pushed cocking handle forward.d. Moved weapon from shoulder or away from face.e. Performed the five-point safety check.f. Reloaded, aimed, and pulled the trigger.
--

Figure B-3. Example Station 3 scoresheet.

d. As each group completes this station, each grader should assemble the individuals he graded and give them a thorough critique (5 minutes).

B-6. STATION 4: FIELD ZEROING

This station normally has six setups. Each setup has an M249 AR and a cleaning rod.

a. Each grader should tell the individual the range (300 meters) to the target and have him simulate firing a three-round burst. The grader will then tell the individual what windage corrections are needed to hit the target. The automatic rifleman will then be graded on his actions.

b. The following statement should be read at this station.
DURING THIS PERIOD, YOU WILL BE ORGANIZED INTO FIVE GROUPS AND REQUIRED TO GO THROUGH THE STEPS OF ZEROING AT LONG RANGE. YOU WILL BE ALLOWED FIVE MINUTES TO EXPLAIN AND PERFORM YOUR ACTIONS TO THE GRADER. IF YOU HAVE ANY PROBLEM, ASK YOUR GRADER. THE GROUPS NOT BEING TESTED WILL REMAIN TO THE REAR OF THE STATION WITH THEIR BACKS TOWARD THE WORK AREA UNTIL THEY ARE CALLED.

c. A scoresheet, like the example in Figure B-4, should be used in grading individual performance.

<p style="text-align: center;">Station 4 FIELD ZEROING CHECKLIST</p> <ol style="list-style-type: none">1. Placed original range setting of 300 meters and zero windage on the rear sight.2. Made corrections for windage.3. Made corrections for elevation.4. Simulated firing second burst and hitting target.
--

Figure B-4. Example Station 4 scoresheet.

d. As each group completes this station, each grader should assemble the individuals he graded and give them a thorough critique (5 minutes).

B-7. STATION 5: ENGAGEMENT OF A LINEAR AND A DEEP TARGET

This station normally has six setups. Each setup should have a punchboard-type training aid or a blackboard and chalk.

a. The individual is required to show his initial point of aim, direction of manipulation, and extent of manipulation for a linear (single automatic rifleman) and a deep target (automatic riflemen employed in pairs). The individual is also asked what rate of fire he would use to engage these targets if the rate were not stated in the fire command.

b. The following statement should be read at this station.

DURING THIS PERIOD, YOU WILL BE ORGANIZED INTO FIVE GROUPS AND REQUIRED TO EXPLAIN HOW TO ENGAGE DIFFERENT TARGETS WITH THE AUTOMATIC RIFLE EMPLOYED SINGLY AND IN PAIRS. YOU WILL BE ALLOWED FIVE MINUTES FOR SIMULATED ENGAGEMENT OF TWO TYPES OF TARGETS. IF YOU HAVE ANY QUESTIONS, ASK YOUR GRADER. THE GROUPS NOT BEING TESTED WILL REMAIN TO THE REAR OF THE STATION WITH THEIR BACKS TOWARD THE WORK AREA UNTIL THEY ARE CALLED.

c. A scoresheet, like the example in Figure B-5, should be used in grading individual performance.

<p style="text-align: center;">Station 5 ENGAGEMENT OF A LINEAR AND A DEEP TARGET CHECKLIST</p> <p>1. Linear (single AR): Used initial point of aim. Used proper manipulation.</p> <p>2. Deep (ARs employed in pairs): Used initial lay. Used proper manipulation.</p> <p>3. Used sustained rate of fire.</p>
--

Figure B-5. Example Station 5 scoresheet.

d. As each group completes this station, each grader should assemble the individuals he graded and give them a thorough critique (5 minutes).

APPENDIX C

M249 AUTOMATIC RIFLE IN AIR DEFENSE

This appendix describes the use of the M249 AR in an air defense role, including the concept and two techniques for applying lead. Also discussed are the rules of engagement and firing positions.

C-1. PASSIVE AND ACTIVE MEASURES

A unit can take passive and active measures to defend itself against enemy air attack. Although volume fire is the key, there is a need to coordinate fires.

a. Passive measures are those that help the unit identify enemy aircraft before the aircraft locate the unit, make the unit difficult to locate, and make the unit less vulnerable when attacked. The unit must develop and practice camouflage as a passive measure. Concealment from the air must be considered when selecting routes, transportation means, or defensive positions. The use of air guards is important to give the unit time to react. Air guards should be used to cover interlocking sectors of visible airspace.

b. Active measures for appropriate reactions to an air attack should be prescribed in unit SOPs. Each of the two techniques for applying lead is based on delivering a heavy volume of fire ahead of the target. The idea is to have every soldier in the unit engage the target. To achieve volume fire, soldiers armed with M249s should fire at the cyclic rate.

c. If an aircraft is attacking his position, the soldier sees the aircraft in a head-on or diving view. To engage this aircraft, the soldier would fire slightly above its nose. Adjacent positions would see the aircraft in a crossing view. To engage the aircraft, these units would have to apply a proper lead. The method of applying lead depends on the technique used.

(1) The first technique is the **football-field technique** (Figure C-1, page C-2). When engaging high-performance aircraft (those flying in excess of 200 miles per hour), automatic riflemen should apply a one-football-field lead in front of the target and fire at the rapid rate until the target passes through the tracer stream. If the target is a low-performance aircraft, such as a helicopter, with a speed of 200 miles per hour or less, automatic riflemen should apply half a football-field lead in front of the target, firing the cyclic rate. With all soldiers firing, a curtain of fire is formed because of slight differences in each soldier's estimate of the distance and lead.

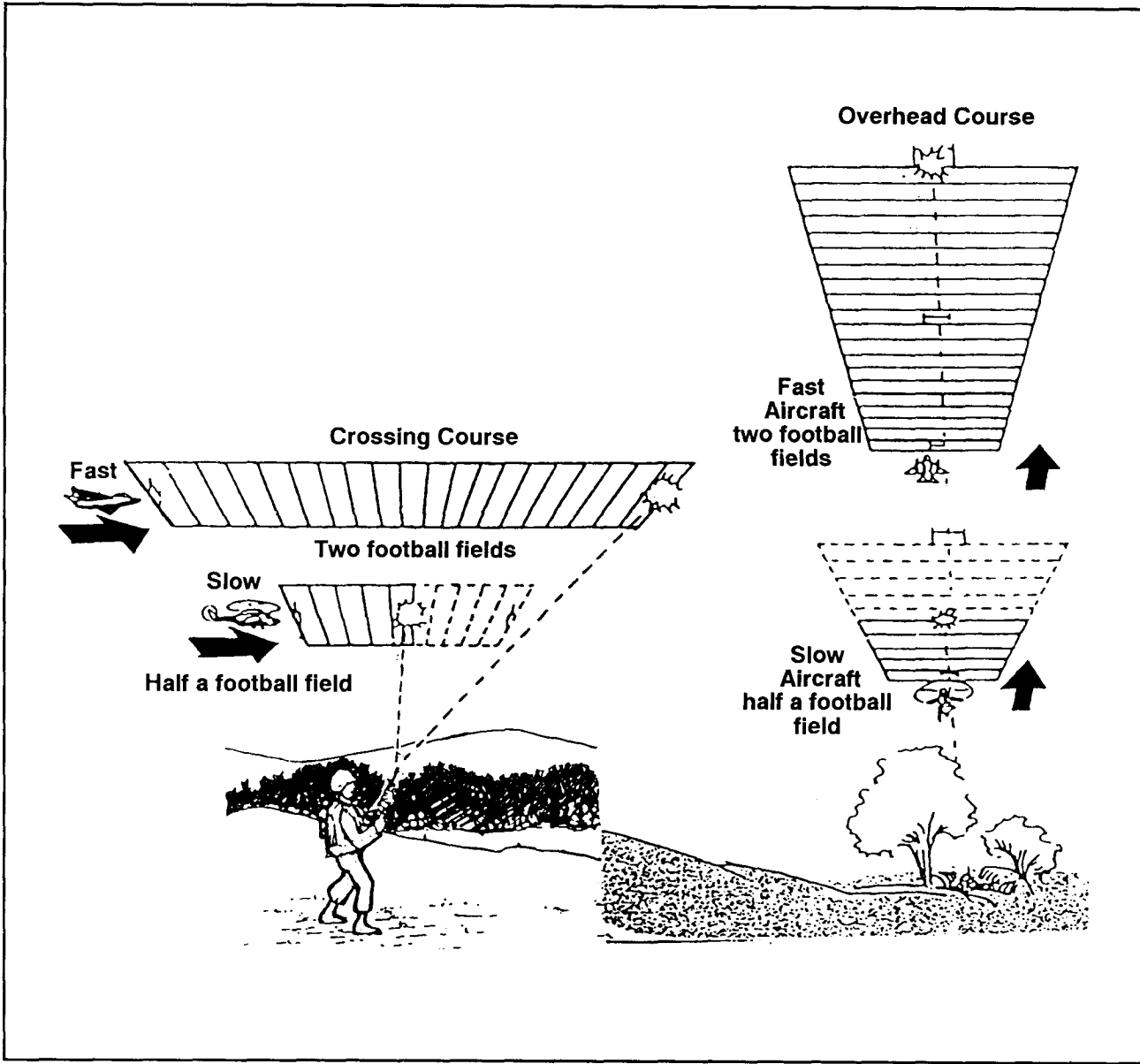

Figure C-1. Football-field technique.

(2) The next technique is the **reference-point technique** (Figure C-2). The unit leader designates terrain features as reference points. Upon spotting enemy aircraft, the leader commands, ENEMY AIR, REFERENCE POINT 1. At this time, the M249 automatic rifleman points his weapon at reference point 1, elevates it about 45 degrees above the ground, and fires on command. Once he sights the target, he can make minor adjustments to align his fire on the target.

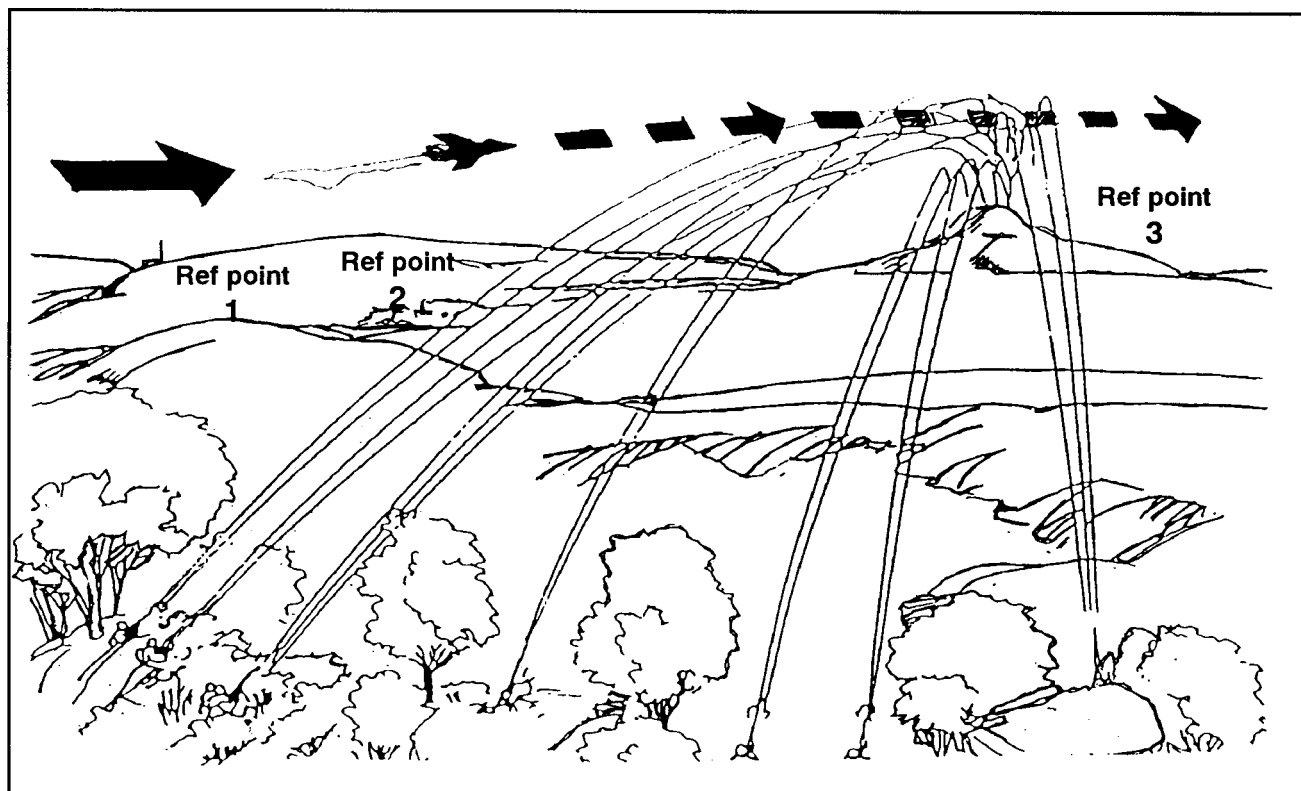

Figure C-2. Reference-point technique.

C-2. USE OF TRACERS

When planning for air defense, the leader should consider the use of tracers so the automatic rifleman can observe the tracer stream and better align his fire on the target. A unit may engage an attacking aircraft without command. If an aircraft is not attacking, the unit may not fire on it unless ordered to do so.

C-3. FIRING POSITION

When firing the M249 in an air defense role, the automatic rifleman should fire from a protected position if possible. When not in a fighting position, he must position the weapon so he has some type of support. In an emergency, another soldier can provide a firing support. In the offensive, the hip-firing position is recommended.

APPENDIX D

RANGE SAFETY

This appendix recommends safety precautions for the ranges described in this manual, but it does not replace AR 385-63 or local regulations. Range safety requirements vary because of the different requirements of the courses of fire.

D-1. SAFETY PRECAUTIONS

The following safety precautions must be observed during all marksmanship training.

- Display a red flag (red light for night firing) at the entrance to the range or in some other prominent location on the range during firing.
- Always assume that weapons are loaded until they have been thoroughly examined and found to contain no ammunition and barrel is clear.
- Mark firing limits with red-and-white-striped poles that are visible to all firers.
- Never place obstructions in the muzzles of weapons about to be fired.
- Keep all weapons in a prescribed area with proper safeguards when not in use.
- Do not permit smoking near ammunition, explosives, or flammables.
- Wear hearing protection devices during firing.

D-2. RANGE PROCEDURES

The range can be a dangerous place, especially if safety procedures are not followed. Everyone must stay alert and adhere to the following precautions.

a. Before Firing.

- (1) Close all prescribed roadblocks and barriers, and post necessary guards.
- (2) Check all weapons to ensure that they are clear of ammunition and obstructions, and that the cover feed mechanism assemblies are UP to show they are cleared.
- (3) Brief all personnel on the firing limits of the range and firing lanes.
- (4) Obtain range clearance from the installation range-control office.

(5) Check the downrange area before firing to ensure that all personnel and equipment are clear of the area.

(6) Keep a complete first-aid kit on the range.

(7) Locate medical personnel on or near the range where they can be contacted quickly.

(8) Have all weapons checked by an officer or noncommissioned officer to ensure that they are operational.

(9) Do not handle weapons except on command from the tower operator or the officer in charge.

(10) Draw ammunition and issue it only on command of the officer in charge. When two or more lots of ammunition are used for firing, the officer in charge must ensure that the lots are separated and properly identified so that identification can be made by lot numbers in case of an accident or malfunction.

(11) Protect all ammunition from the direct rays of the sun.

(12) Do not allow anyone to move forward of the firing line without permission of the tower operator, safety officer, or officer in charge.

b. During Firing.

(1) Immediately order CEASE FIRE if an unsafe condition is noted during firing. Do not resume firing until directed to by the officer in charge.

(2) During firing, all personnel on the range must be aware of the danger in moving forward of the firing line to score their targets. Before the firing line is clear and anyone is allowed forward, the officer in charge or the safety officer will clear all M249s.

(3) In clearing the M249, the safety officer or NCO will inspect each weapon that was fired on the firing line by making sure the bolt is locked to the rear and the safety is on. He makes sure each barrel is clear by running a cleaning rod through the barrel until he can see the end of the rod in the receiver. He performs the five-point safety check. Then, he eases the bolt forward and raises the feed cover and checks behind the bolt.

c. When Firing During Darkness.

(1) Check the downrange area before firing to ensure that all personnel and equipment are clear of the area. This will be done by asking three times over a public address system IS THERE ANYONE DOWNRANGE? Pause each time long enough to permit a response.

(2) Use a blinking red light in addition to the red flag. Display it at the entrance to the range or at some other prominent location.

(3) Mount two red lights on the striped poles marking the limits of fire. They must be visible to all firers.

(4) Do not allow anyone to move from his position until told to do so by the officer in charge.

d. After Firing.

(1) Have safety personnel inspect all weapons to ensure that they are clear and check to determine if the soldiers have any brass, links, or live ammunition.

(2) When weapons have been cleared, keep them in a prescribed area with the bolt forward, safety on the SAFE position, and the feed cover mechanism assembly raised.

APPENDIX E

EMPLOYMENT

Though the automatic rifle has changed, the role of the automatic rifleman has not since its conception circa World War I. The automatic rifleman supports the infantry squad in the offense and defense. The M249 AR provides accurate fire approaching that of the rifle yet gives the heavy volume of fire common to a machine gun. The automatic rifle is a squad leader's weapon.

E-1. OFFENSE

In the offense, the automatic rifle contributes primarily to the maneuver element. That is, it gives the squad leader the fires of “ten soldiers” for the close-quarter fight. Depending on the tactical situation, it may also be used in the base-of-fire element.

a. **Maneuver Element.** The squad undertaking the assault brings its automatic rifles with it to provide additional firepower. These weapons are fired either from the biped or in an assault mode from the hip or underarm position. They target any enemy automatic weapons anywhere on the squad's objective. Once the enemy automatic weapons have been destroyed, or if there are none, the automatic riflemen distribute their fire over that portion of the objective that corresponds to their team's positions. In terms of engagement ranges, the automatic rifles in the assault engage from within the last 300 meters and most probably at point-blank ranges.

b. **Base-of-Fire Element.** Automatic rifles organic to the squad may augment the fires of the machine gun in the base of fire. In this case, the platoon sergeant positions and controls the fires of the automatic riflemen. Automatic rifle targets include key enemy weapons not covered by machine gun fire or groups of enemy targets either on the objective or attempting to reinforce or counterattack. In terms of engagement ranges, automatic rifles in the base-of-fire element may find themselves firing at targets anywhere from 800 meters to within the last 300 meters where the assault takes place. These ranges do not reflect a hard rule, simply a practical average. The nature of the terrain and desire to achieve some stand-off leads the platoon leader to the correct tactical positioning of the base-of-fire element. If automatic rifles are employed as part of the base of fire, then that element must be within 800 meters.

c. **Task Organization of Automatic Rifles.** The organization of the squad into two fire teams does not prevent the squad leader from organizing his automatic rifles to conform to a specific situation. For example, when assaulting, he may require more firepower than can be provided by one

team. He may designate the automatic rifles and one fire team leader to establish a base of fire, while he continues the assault with the remainder of the squad. However, such an organization takes time to accomplish and reduces both the squad's flexibility and its on-hand firepower in the assault.

E-2. DEFENSE

The dismounted infantry defense centers around the platoon's machine guns. The platoon leader sites the rifle squad to protect the machine guns against the dismounted assault of an enemy formation. The automatic rifle provides the requisite range and volume of fire to cover across the squad front in the defense. The squad leader sites each of his automatic rifles to cover the entire squad sector or cover an overlapping sector with the other automatic rifle. Automatic rifles can augment platoon and company machine gun fire out to the maximum ranges. The engagement range of a squad leader's weapon may extend from the last 300 meters where the enemy began his assault to point-blank range. Automatic rifle targets include enemy automatic weapons and command and control elements.

GLOSSARY

AAR	after-action review
ammo	ammunition
AR	automatic rifle; army regulation
ARTEP	Army Training and Evaluation Program
attn	attention
BFA	blank firing attachment
CLP	cleaning, lubricant, and petroleum
cm	centimeters
co	company
CPT	captain
DA	Department of the Army
FM	field manual
FPF	final protective fires
FPL	final protective line
FSN	federal stock number
FTX	field training exercise
GTA	graphic training aid
HQ	headquarters
IAW	in accordance with
IET	initial entry training
IN	infantry
indiv	individual
IOAC	infantry officer's advanced course
IOBC	infantry officer's basic course
LFX	live-fire exercise
LSA	lubricating oil, semifluid, automatic weapons
LTA	local training area
m	meters
METL	mission-essential task list
MILES	multiple-integrated laser engagement system

mm	millimeter
MOPP	mission-oriented protection posture
mph	miles per hour
MPRC	multipurpose range complex
MTA	major training area
MTP	mission training plan
N/A	not applicable
NATO	North Atlantic Treaty Organization
NBC	nuclear, biological, and chemical
NCO	noncommissioned officer
NCOES	Noncommissioned Officer Education System
NCOIC	noncommissioned officer in charge
NVD	night vision devices
OIC	officer in charge
pam	pamphlet
PDF	principal direction of fire
plt	platoon
PMT	preliminary marksmanship training
POPP	pull, observe, push, and press (a memory aid)
prac	practice
qual	qualification
RBC	rifle bore cleaner
rds	rounds
SAW	squad automatic weapon
sec	seconds
SM	soldier's manual
SMCT	soldier's manual of common tasks
SOP	standing operating procedures
sqd	squad
SSG	staff sergeant
SSN	social security number
STP	soldier's training publication
STRAC	standards in training commission
STX	situational training exercise

TC	training circular
T&E	traversing and elevating
TM	technical manual
TRADOC	US Army Training and Doctrine Command
US	United States

REFERENCES

Sources used

These are the sources quoted or paraphrased in this publication.

- FM 3-3.** NBC Contamination Avoidance.
30 September 1986.
- FM 3-4.** NBC Protection. 29 May 1992.
- FM 3-5.** NBC Decontamination. 23 July 1992.
- FM 7-8.** Infantry Platoon and Squad. 22 April 1992.
- FM 21-26.** Map Reading and Land Navigation.
7 May 1993.
- FM 21-60.** Visual Signals, 30 September 1987.
- TM 9-1005-201-10.** Operator's Manual Machine Gun, 5.56-mm,
M249 w/Equip. 26 July 1991.
- TM 11-5855-213-10.** Operator's Manual for Night Vision Sight,
Individual Served Weapon, AN/PVS-4.
1 April 1992.

Documents needed

These documents must be available to the intended users of this publication.

- AR 385-63.** Policies and Procedures for Firing Ammunition
for Training, Target Practice and Combat.
15 October 1983.
- DA Form 7304-R.** Scorecard for M249 AR (LRA).
- DA Pamphlet 350-38.** Training Standards in Weapon Training.
September 1990.

INDEX

- adjustment of fire, 5-14**
 - adjusted aiming point method, 5-15
 - sight corrections method, 5-14
- advanced marksmanship, 5-2, 6-34, 7-4, 7-9, 7-12**
- air defense**
 - active, C-1
 - football-field technique, C-1
 - reference point technique, C-2
 - passive, C-1
- ammunition, 5.56-mm, 1-6**
 - ball, 1-7
 - blank, 1-8
 - tracer, 1-7
- application of fire, 5-14, 6-5**
- assault fire exercise, 6-40**
- assembly, 2-17**

- barrel group, 2-5 (Figure 2-2)**
 - assembly, 2-18
 - cleaning, 2-12
 - disassembly, 2-7
 - inspection, 2-11
 - lubrication, 2-16
 - preventive maintenance, 2-16
- basic marksmanship, 5-2, 5-27, 7-4, 7-7, 7-12**
- beaten zone, 6-2**
- bipod group, 2-5 (Figure 2-2)**
 - assembly, 2-17
 - cleaning, 2-12
 - disassembly, 2-10
 - inspection, 2-12
- bipod positioning, 3-7**

- blank firing attachment, M15A2, 1-9**
 - installation, 1-9
- buttstock and buffer assembly group, 2-5 (Figure 2-2)**
 - assembly, 2-18
 - cleaning, 2-12
 - disassembly, 2-9
 - inspection, 2-11
- cadre coaches, 7-2**
- characteristics of fire, 6-1**
 - beaten zone, 6-2
 - cone of fire, 6-1
 - danger space, 6-2
 - maximum ordinate, 6-1
 - trajectory, 6-1
- classes of fire, 6-2**
 - enfilade, 6-3
 - fixed, 6-4
 - flanking, 6-3
 - frontal, 6-3
 - grazing, 6-3
 - oblique, 6-3
 - plunging, 6-3
 - searching, 6-4
 - traversing, 6-4
 - traversing and searching, 6-4
- cleaning, 2-12**
- clearing, 2-1**
- components, 1-1, 1-2 (Table 1-1), 1-3 (Figure 1-2)**
- concentration of fire, 6-7, 6-8**
- cone of fire, 6-2**
- DA Form 7304-R, Scorecard, 5-50, 5-51**
- danger space, 6-2**
- dead space, 6-15**

defense, E-2
description, 1-1
destruction, 4-4
direct lay, 5-14
disassembly, 2-4
distribution of fire, 6-7
dry-fire exercises, 5-19
 immediate-action, 5-19
 loading, 5-19
 operational, 5-20
 sight change, 5-20
 sight setting, 5-20
 traverse and searching, 5-20
 unloading, 5-19
dry-fire proficiency examination, 5-21, B-1

effects of wind, 5-16
 clock system, 5-16
 wind measurement, 5-17

elevation correction, 3-5, 5-29, 5-30
enfilade fire, 6-3

field firing exercise, 6-34
final protective fire, 6-15
final protective line, 6-15
fire control, 6-16, 6-22
fire commands, 5-18, 6-24
 abbreviated, 6-28
 initial, 6-24
 subsequent, 6-27

firing positions
 fighting, bipod-supported, 5-8
 hip, 6-39, C-3
 prone, bipod-supported, 5-7
 shoulder, 6-36
 underarm, 6-38

- Firing Table I**, 5-36 (Table 5-1)
- Firing Table II**, 5-42 (Table 5-2)
- Firing Table III**, 5-49 (Table 5-3)
- Firing Table IV**, 6-36 (Table 6-2)
- Firing Table V**, 6-41 (Table 6-3)
- five-point safety check**, 2-1
- fixed fire**, 6-5
- flanking fire**, 6-3
- front sight**, 1-4
- frontal fire**, 6-3
- function check**, 2-21
- functioning, sequence of**
 - chambering, 3-4
 - cocking, 3-4
 - ejecting, 3-4
 - extracting, 3-4
 - feeding, 3-4
 - firing, 3-4
 - locking, 3-4
 - unlocking, 3-4
- gas cylinder group**, 2-5 (Figure 2-2)
 - assembly, 2-17
 - cleaning, 2-12
 - disassembly, 2-10
 - inspection, 2-12
- grazing fire**, 6-3, 6-15
- grid square overlay**, 5-24, 5-28
- handguard group**, 2-5 (Figure 2-2)
 - assembly, 2-18
 - cleaning, 2-12
 - disassembly, 2-8
 - inspection, 2-11

immediate action, 4-3

lateral distance measure, 6-34

live-fire exercise, 5-27

loading, 3-1

belt-fed, 3-2

magazine-fed, 3-2

lubrication, 2-12

maintenance

after firing, 2-22

before firing, 2-21

during firing, 2-22

during NBC conditions, 2-22

malfunctions, 4-1

marksmanship

advanced, 5-2, 6-34, 7-4, 7-9

basic, 5-2, 5-27, 7-4, 7-7

fundamentals

aim, 5-5, 5-6, 5-10, 5-13

breath control, 5-5, 5-6, 5-10, 5-11, 5-13

steady position, 5-5, 5-6, 5-9, 5-10, 5-13

trigger control, 5-5, 5-7, 5-10, 5-11, 5-13

preliminary, 5-1, 5-5, 7-4, 7-5

maximum ordinate, 6-1

moving targets, fundamentals of, 5-11

night firing, fundamentals of, 5-9

nightsight, AN/PVS-4, 5-42

oblique fire, 6-3

offense, E-1

- operating rod group, 2-5 (Figure 2-2)**
 - assembly, 2-19
 - cleaning, 2-12
 - disassembly, 2-6
 - inspection, 2-11
 - lubrication, 2-16
 - preventive maintenance, 2-16

- peep sight, 1-4**
- plunging fire, 6-3**
- predetermined fires, 6-14**
- preliminary marksmanship, 5-1, 5-5, 7-4, 7-5**
- preventive maintenance, 2-12**
- principal direction of fire, 6-15**

- qualification, 5-36, 5-50**

- range card, 6-16, 6-23**
- range determination, 6-30**
- range estimation, 6-30**
 - appearance-of-objects method, 6-32
 - 100-meter unit-of-measure method, 6-32
- range layout, 5-21, 5-22 (Figure 5-13)**
- range safety, D-1**
 - after firing, D-3
 - before firing, D-1
 - during firing, D-2
 - when firing during darkness, D-2
- rate of fire, 6-7, 6-8**
 - cyclic, 6-8
 - rapid, 6-8
 - sustained, 6-8
- rear sight, 1-4**

receiver group, 2-5 (Figure 2-2)

- assembly, 2-17
- cleaning, 2-12
- disassembly, 2-10
- inspection, 2-12
- lubrication, 2-16
- preventive maintenance, 2-16

remedial training, 5-21**remedial action, 4-4**

- cold weapon, 4-4
- hot weapon, 4-4

safety, 1-6, D-1**safety check, five-point, 2-1****Scorecard, DA Form 7304-R, 5-50, 5-51****searching fire, 6-5****sector of fire, 6-15**

- primary, 6-16
- secondary, 6-16

sights

- front, 1-4
- peep, 1-4
- rear, 1-4
- settings
 - corrections, 3-6; 3-7 (Table 3-1), 5-14, 5-29
 - elevation, 1-4, 3-5
 - windage, 1-4, 3-6

standing operating procedures, 6-23**stoppages, 4-2****target analysis, 5-26****target engagement**

- by single automatic rifleman, 6-8
- by pair of automatic riflemen, 6-11
- during limited visibility, 6-14

- targets**
 - area, 5-24, 6-6, 6-8, 6-11
 - deep, 6-6, 6-10, 6-12
 - linear, 6-6, 6-8, 6-12
 - linear with depth, 6-6, 6-11, 6-13
 - point, 5-23, 6-6, 6-8
 - zero, 5-24, 5-26
- 10-meter firing**, 5-30
 - qualification, 5-36
- trainer assessment**, 7-1
- trainer certification**, 7-10
- training strategy**, 5-2
- trajectory**, 6-1
- transition firing**, 5-37
 - during limited visibility, 5-42
- traverse and search, fundamentals of**, 5-14
- traversing and searching fire**, 6-5
- traversing fire**, 6-5
- trigger mechanism group**, 2-5 (Figure 2-2)
 - assembly, 2-17
 - cleaning, 2-12
 - disassembly, 2-9
 - inspection, 2-11

- unit training**, A-1
- unloading**, 3-3
 - belt-fed, 3-3
 - magazine-fed, 3-3

- wind measurement**, 5-17
 - observation method, 5-17
 - pointing method, 5-17
- windage correction**, 3-6, 5-29

zeroing, 5-27, 5-29,
AN/PVS-4, 5-43, 5-47
field, 5-29
10-meter, 5-27

SCORECARD FOR M249 AR

For use of this form, see FM 23-14; the proponent agency is TRADOC

SEE BACK OF THIS FORM FOR INSTRUCTIONS

1. NAME		2. SSN		3. UNIT				4. DATE		5. LANE					
6. TABLE I (10-METER W/NBC)				7. TABLE II (DAY TRANSITION W/NBC)						8. TABLE III					
TASK	RANGE (METERS)	TIME	HITS POINTS	TASK	RANGE (METERS)	TIME	**PRAC HIT MISS		**QUAL HIT MISS		TASK	RANGE (METERS)	PRAC/INSTR HIT MISS		
1*	10	N/A	N/A	1*	300	N/A	N/A	N/A	N/A	N/A	1*	25	N/A	N/A	
2*	10	N/A	N/A	2	200	5 sec					2*	200			
3*	10	N/A	N/A	3	400	10 sec					3*	400			
4*	10	N/A	N/A	4	100	10 sec					4*	100			
5	10	20 sec		5	300	15 sec					5*	300			
6	10	40 sec		6	100 300	20 sec					6*	100			
7	10	40 sec		7	200 400	20 sec						N/A			
				8	100 200 400	25 sec						N/A			
9.															
TOTAL <input style="width: 50px;" type="text"/>				*NONSCORED TASKS ** 5 POINTS PER HIT				TOTAL <input style="width: 50px;" type="text"/>				TOTAL SCORE <input style="width: 50px;" type="text"/>			
EXPERT 90 - 106				FIRST CLASS 80 - 89				SECOND CLASS 70 - 79							
10. OIC SIGNATURE						11. GRADER SIGNATURE						12. RATING			
<p>AUTHORITY: 10USC30129(g) Executive Order 9397. PRINCIPAL PURPOSE(S): Records Individual's performance on record fire range. ROUTINE USE(S): Evaluation of Individual's proficiency and basis for determination of award of proficiency badge; SSN is used for positive identification purposes only MANDATORY OR VOLUNTARY DISCLOSURE AND EFFECT ON INDIVIDUAL NOT PROVIDING INFORMATION: Voluntary, individuals not providing information cannot be rated/scored on a mass basis.</p>															

The following procedures will be used to fill out the scorecard.

1. NAME: Enter last name, first name, middle initial, and rank.
2. SSN: Enter automatic rifleman's social security number.
3. UNIT: Enter unit designation.
4. DATE: Enter date of firing.
5. LANE: Enter the lane number for the firing point of the automatic rifleman.
6. HIT: For Firing Table I, enter the number of rounds impacting within the spaces in Tasks 5 through 7.
7. HIT: For Firing Table II, enter an X for a hit and enter an 0 for a miss for Tasks 2 through 8.
8. HIT: (NOT FOR QUALIFICATION, USE FOR PRACTICE AND INSTRUCTION) For Firing Table III, enter an X for a hit a an 0 for a miss for Tasks 2 through 6.
9. POINTS FOR FIRING TABLES I AND II: For Firing Table I, enter 1 point for each round impacting within the scoring space (maximum of seven for each space) in Tasks 5 through 7. For Firing Table II, enter 20 points for each target hit in tasks 2 through 8 whether target is hit on the first or second burst.

TOTAL SCORE: Enter the total of combined points. The automatic rifleman must score 35 points on Firing Table I and 35 points on Firing Table II to meet the minimum score on each. The following qualification levels are provided:

EXPERT	90 - 106
AUTOMATIC RIFLEMAN 1ST CLASS	80 - 89
AUTOMATIC RIFLEMAN 2D CLASS	70 - 79
UNQUALIFIED	0 - 69

10. OIC SIGNATURE: OIC's signature.
11. GRADER SIGNATURE: Grader's signature.
12. RATING: Enter automatic rifleman's rating of performance.

FM 23-14
26 JANUARY 1994

By Order of the Secretary of the Army:

Official:

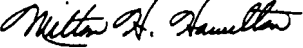
MILTON H. HAMILTON
*Administrative Assistant to the
Secretary of the Army*
06080

GORDON R. SULLIVAN
*General, United States Army
Chief of Staff*

DISTRIBUTION:

Active Army, USAR, and ARNG: To be distributed in accordance with DA Form 12-11E, requirements for FM 23-14, M249 Light Machine Gun in the Automatic Rifle Role (Qty rqr block no. 1059).